



# Sulfur

Catálogo de  
Produtos

# Sulfer

Rua Romildo Bortoli, 803  
Bairro Rude José Spanhol  
Ampére/PR

 46 3547 3215

[sulferdistribuidora.com.br](http://sulferdistribuidora.com.br)



# Catálogo com mais de **5 mil produtos** de alta qualidade para **transformar** **os seus projetos!**

Nossa trajetória é marcada pela dedicação em oferecer os melhores produtos e serviços, sempre visando superar as expectativas dos nossos clientes.

Com um amplo estoque de mais de 5 mil produtos, estamos prontos para suprir todas as necessidades do setor de marcenaria. Desde ferramentas de alto desempenho até materiais de primeira linha, nossa variedade e qualidade são incomparáveis.

Mas não paramos por aí!

Investimos em **nossa própria frota de entrega**, garantindo que seus pedidos cheguem até você com agilidade e segurança. Com controle total sobre o processo logístico, podemos oferecer uma entrega rápida e eficiente, levando os produtos diretamente à sua porta.

Além disso, nosso compromisso com o atendimento ao cliente é inabalável. Nossa equipe altamente capacitada está sempre pronta para oferecer suporte técnico, orientações e recomendações personalizadas.

**Sua satisfação é nossa prioridade número um!**



# O braço direito do marceneiro.

Produtos de alta qualidade para  
transformar os seus projetos!

Dist. Sulfer



# ARAMADOS



103275 - GAVETA FRUTEIRA  
DESL BAIXA SLIM  
L370 X A100 X P380 MM  
CROMADO



103274 - GAVETA FRUTEIRA  
DESL BAIXA SLIM  
L370 X A100 X P380 MM  
PTO FOSCO

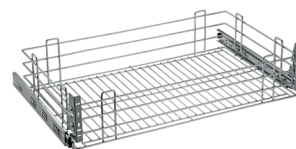

103272 - GAVETA DESLIZANTE  
L570 X A190 X P450 MM  
CROMADO

103277 - GAVETA FRUTEIRA  
DESL BAIXA SLIM  
L470 X A100 X P380 MM  
CROMADO

103276 - GAVETA FRUTEIRA  
DESL BAIXA SLIM  
L470 X A100 X P380 MM  
PTO FOSCO



103268 - ESCORREDOR DE  
LOUCAS AEREO COM BANDEJA INOX  
S BLIND L570 X A90 X P260



103273 - GAVETA ESCORREDOR  
COM BANDEJA INOX  
L570 X A210 X P450 MM  
CROMADO

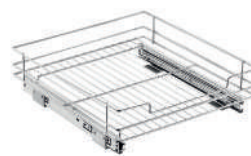

103278 - GAVETA ORGANIZADORA  
CROMADA L35 X A10,5 X P38



103286 - ORGANIZADOR DE  
PRATELEIRA JULIANA  
L230 X A250 X P230 MM  
CROMADO



101919 - QUADRO P/PASTA  
SUSPENSA 35KG 838X414MM

101918 - QUADRO P/PASTA  
SUSPENSA 35KG 422X414MM



103288 - ORGANIZADOR PARA  
ARMARIO CECILIA  
L210 X A150 X P320 MM  
PTO FOSCO



103290 - ORGANIZADOR SUSP  
P ARMARIO ARIANE  
L340 X A130 X P280 MM  
PTO FOSCO

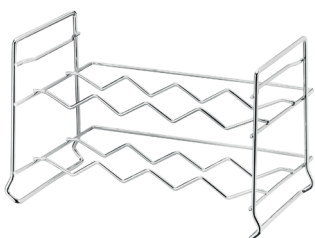

103260 - ADEGA EMPILHABEL MERLOT  
L380 X A220 X P255 MM  
CROMADO



103261 - ADEGA EMPILHABEL MERLOT  
L380 X A220 X P255 MM  
PRETO FOSCO

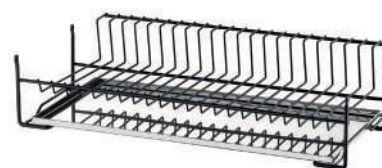

103269 - ESCORREDOR DE LOUCAS  
AEREO FIXO CBAND. INOX  
L570 X A130 X P260 MM PTO

# ARAMADOS



103262 - BARRA PARA SUPORT SILVANA  
58 X 1000 MM Í CROMADO



103263 - BARRA PARA SUPORT SILVANA  
58 X 1000 MM  
PRETO FOSCO



103264 - COLUNA DESLIZANTE CO 4 CESTOS  
L250 X A1220 A 1500 X 470MM

103265 - COLUNA DESLIZANTE CO 5 CESTOS  
250 X 1460 A 1750 X 455 MM



103266 - CONJ DE PRATELEIRA  
ARTICULADA PARA CANTO  
L740 X A600 X P340MM CROMADO



103297 - PORTA GARAFAS LATAS  
TRIPLO LATERAL CTRILHO  
L120 X A610 X P450 MM PTO



103301 - PORTA OBJETOS MULTIUSO  
IMBUIA L95 X A 350 X P300 MM  
CROMADO



103296 - PORTA GARAFAS DUPLO  
SEM BLINDAGEM  
L230 X A482 X P455 MM  
CROMADO

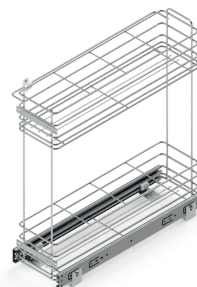

101800 - PORTA LATA CROMADO  
DUPLO CORREDICA TElesc  
INFERIOR A 490 X L160 X P 460



102708-PORTA GARAFAS  
DESLIZANTE COM TRILHO  
TElesc L120 X A380 X P450 MM  
CROMADO

# ARAMADOS



102837 - TULHA P ROUPAS 250X450MM  
 102838 - TULHA P ROUPAS 300X450MM  
 102839 - TULHA P ROUPAS 350X450MM  
 102840 - TULHA P ROUPAS 400X450MM



103255 - TULHA DESLIZ S BLINDAGEM  
 L325 X A445 X P380 MM  
 CROMADO

103324 - TULHA DESLIZ S BLINDAGEM  
 L400 X A445 X P380 MMQ  
 CROMADO



103293 - PORTA CINTO LIBERTY  
 L70 X A35 X P300 MM  
 CROMADO

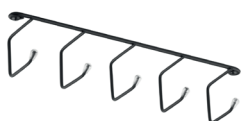

103298 - PORTA OBJETOS  
 UTENSILIOS MARGARIDA  
 L270 X A47 X P50 MM  
 PTO FOSCO



103305 -PORTA OBJETOS  
 UTENSILIOS MARGARIDA  
 L270 X A47 X P50 MM  
 CROMADO



103294 - PORTA CINTO LIBERTY  
 L70 X A35 X P300 MM  
 PTO FOSCO



103303 - PORTA OBJETOS PEQUI  
 L310 X A60 X P110 MM  
 CROMADO



103306 - PORTA TOALHA DUPLO SLIM  
 L85 X A150 XP440 MM  
 CROMADO



103258 -PORTA TOALHA TRIPLO  
 SEM BLINDAGEM  
 L95X A45 X P450MM CROMADO

101804 - PORTA TOALHA DUPLO  
 C/ TELESC. BRANCO

101806 -PORTA TOALHA TRIPLO  
 C/TELESC. BRANCO



103304 - PORTA OBJETOS  
 PEQUI  
 L310 X A60 X P110 MM  
 PTO FOSCO



103307 - SUPORTE DUPLO  
 PARA CONDIMENTOS NATI  
 CROMADO



103312 -SUPORTE P  
 DETERGENTE E ESPONJA ANE  
 CROMADO

# ARAMADOS



103309 -SUPORTE P TACAS CURVO  
MELISSA L110 X A35 X P400 MM  
PTO FOSCO



103315 -SUPORTE P TACAS RETO  
AMY L250 X A35 X P105 MM  
PTO FOSCO



103317 -SUPORTE P TACAS RETO  
AMY L400 X A35 X P105  
MM PTO FOSCO



103316 -SUPORTE P TACAS RETO AMY  
L400 X A35 X P105 MM CROMADO

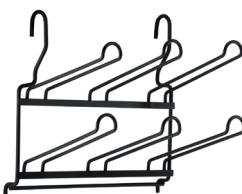

103311 - SUPORTE P COPOS DAIANE  
PTO FOSCO



103320 - SUPORTE P/ XÍCARA EDUARDA  
L145 X A40 X P260 MM CROMADO

103314-SUPORTE P TACAS RETO  
AMY L250 X A35 X P105 MM CROMADO



103318 - SUPORTE  
P TALHERES ROBERTA  
PTO FOSCO



103319 - SUPORTE P TEMPERO NILDA  
PTO FOSCO

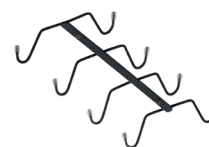

103321 - SUPORTE P/ XÍCARA EDUARDA  
L145 X A40 X P260 MM PTO FOSCO

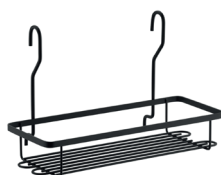

103322 -SUPORTE SIMPLES  
PARA CONDIMENTOS LUCIA  
PTO FOSCO



103313 -SUPORTE P LIXEIRA ROSELI  
CROMADO



103323 - SUPORTE TRIPLO  
PARA ROLOS CRIS  
CROMADO



# ARAMADOS



102702 - CALCEIRO DESLIZANTE SLIM L380 X A220 X P430MM



102704- CALCEIRO DESLIZANTE TUBULAR C/12 VARETAS L400XA330XP450MM



102703-CALCEIRO DESLIZANTE C/12 VARETAS 380X330X450MM



101854 - CALCEIRO DESLIZANTE CD 135 600MM LARGURA

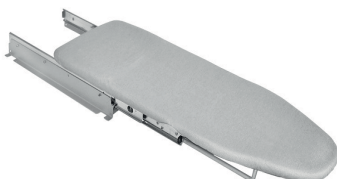

101920 - TABUA PASSAR DESLIZANTE FGV ALUMI TP 450 MEDIDA L 285 A 69 C 795



103254 - TABUA DE PASSAR ROUPA COM CAPA SCHMIT L300 X A150 X P480 MM



103295 - PORTA FERRO VIOLETA L170 X A270 X P90 MM CROMADO



103310 - SUPORTE P/ CELULAR RAFAELA PTO FOSCO



101789 - KIT CESTO GIRATORIA C2 350MM BRANCO

101790 - KIT CESTO GIRATORIO C2 350MM CROMADO

101791 - KIT CESTO GIRATORIO C2 600MM BRANCO

101792 - KIT CESTO GIRATORIO C2 600MM CROMADO

# ARAMADOS



103279 -LIXEIRA DESL. DUPLA  
SEM BLINDAGEM SLIM  
19L L345 X A490 X P490MM CROMADO



103280 -LIXEIRA DESL. SIMPLES  
S BLIND. SLIM CESTO  
19L L250 X A490 X P340MM  
CROMADO



103184 - LIXEIRA DESL.  
SIMPLES S BLIND  
CESTO 30L L250 X A600 X P450  
CROMADO



103284 - LIXEIRA LAT DUPLA SLIM  
C 2 CESTOS 12L L300 X A380 X P490MM  
CROMADO



103282 - LIXEIRA DESL. SLIM  
SIMPLES CESTO 12L L240 X A410 X P300 MM  
CROMADO



103283 -LIXEIRA DUPLA DESLIZANT  
C TAMPA FIXA  
L20 L365 X A510 X P460MM



102706 - LIXEIRA DESLIZANTE  
PRETA SLIM CESTO DUPLO 15L  
320X470X450MM



102705 -LIXEIRA DESLIZANTE PRETA  
SLIM 15L L230 X A470 X P340MM

# ARAMADOS



- 101905- GAVETA AVANTBOX TN 450MM INOX
- 101906- GAVETA AVANTBOX TN 450MM PRATA
- 101907- GAVETA AVANTBOX TN 500MM INOX
- 101908- GAVETA AVANTBOX TN 500MM PRATA



103267 - ESCADA PARA BELICHE CURVA  
L300 X A1620 X P380MM CROMADO

103251-ESCADA PARA BELICHE CURVA  
L300 X A1420 X P380MM CROMADA

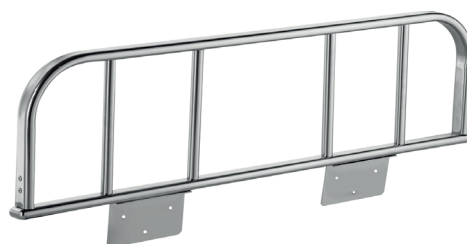

103250 - GRADE PROTETORA  
PARA CAMA L800 X A300MM CROMADO

# SUPORES



- 102743 - SUPORTE ACO DOBRAVEL BRANCO 280MM
- 102744 - SUPORTE ACO DOBRAVEL BRANCO 380MM
- 103727 - SUPORTE ACO DOBRAVEL PRETO 280MM
- 103728 - SUPORTE ACO DOBRAVEL PRETO 380MM



- 102969 - SUPORTE ACO DOBRAVEL COMPACTO TAMPO BRANCO 400MM



- 102846 - SUPORTE MAO FRANCESA BRANCA 170MM
- 102847 - SUPORTE MAO FRANCESA BRANCA 370MM
- 103725 - SUPORTE MAO FRANCESA PRETO 170MM
- 103726 - SUPORTE MAO FRANCESA P RETO 370MM



- 103099-SUPORTE MAO FRANCESA DE ACO PRETA 200MM

- 103100-SUPORTE MAO FRANCESA DE ACO PRETA 250MM

- 103101-SUPORTE MAO FRANCESA DE ACO PRETA 300MM



- 101820 - SUPORTE PRATELEIRA MAO FRANCESA PQ CROMADO A180XL25XP180

- 101819 - SUPORTE PRATELEIRA MAO FRANCESA GR CROMADA A250XL25XP250



- 103094-SUPORTE INVISIVEL 189MM
- 103095-SUPORTE INVISIVEL 239MM
- 103096-SUPORTE INVISIVEL 289MM
- 103097-SUPORTE INVISIVEL 339MM
- 103098-SUPORTE INVISIVEL 439MM

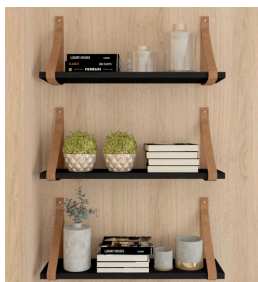

- 103102-SUPORTE MAO FRANCESA DE COURO CARAMELO Cj 2 1000X40MM

- 103103-SUPORTE MAO FRANCESA DE COURO PRETO Cj 2 1000X40MM



- 103243 - SUPORTE TUCANO P 4,5CM
- 103240 - SUPORTE TUCANO M 7 CM
- 103242 - SUPORTE TUCANO G 10CM



- 103093-SUPORTE INVISIVEL UNIVERSAL 13,5X212MM

# SUPORTES



102152 - SUPORTE TV CELSUS



101897-DISCO ROLETADO C/ BUCHA DE METAL



101898-DISPOSITIVO FA PLASTICO BCO 16/19MM



101899-DISPOSITIVO FB PLASTICO BCO 16/19MM



101910-PARAFUSO FA FB ACO 1,4 X 11MM



102156-CANTONEIRA METAL 2 FUROS



102166-SUPORTE L FURO GOTA



102276 -CANTONEIRA ZAMAC 2 FUROS BRANCA



102277-CANTONEIRA ZAMAC 2 FUROS CROMADA



102278 -CANTONEIRA ZAMAC 2 FUROS REFOR. CROMADA



102279-CANTONEIRA ZAMAC 3 FUROS BRANCA



102280 -CANTONEIRA ZAMAC 3 FUROS CROMADA



102285 - CANTONEIRA TRIANGULO BRANCA, 102286 - CANTONEIRA TRIANGULO ZINCADA

# SUPORTES



102773-SAPATA PREGO 14MM  
DESGLIZANTE PRETA



102699-SAPATA NIVELADORA NIQUELADA 20MM SEM BUCHA  
102700-SAPATA NIVELADORA NIQUELADA 31MM SEM BUCHA  
101584-BUCHA SAPATA BITOLA 20MM  
102696-BUCHA SAPATA BITOLA 31MM



102320 - SAPATA REGULAVEL  
PRETA 22MMMM C BUCHA

102752 - SAPATA REGULAVEL  
PRETA 1/4X20MM 20MM



102769-SAPATA ENCAIXE BEGE 15X60MM  
2 FUROS DESGLIZANTE  
102770-SAPATA ENCAIXE BRANCO 15X60MM  
2 FUROS DESGLIZANTE  
102771-SAPATA ENCAIXE PRETO 15X60MM  
2 FUROS DESGLIZANTE  
102772 - SAPATA ENCAIXE CAFE 15X60MM  
2 FUROS DESGLIZANTE



102763-SAPATA PLASTICA BEGE  
15X15MM  
102764-SAPATA PLASTICA BRANCA  
15X15MM  
102765-SAPATA PLASTICA MARROM  
15X15MM



102766-SAPATA ENCAIXE BEGE 15X30MM DESGLIZANTE  
102767-SAPATA ENCAIXE PRETO 15X30MM DESGLIZANTE  
102768-SAPATA ENCAIXE CAFE 15X30MM DESGLIZANTE  
103039-SAPATA ENCAIXE BRANCO 15X30MM DESGLIZANTE



102554-BUCHA 6MM CINZA  
102555-BUCHA 8MM CINZA  
102553-BUCHA 10MM CINZA



102760-BUCHA NYLON FU 06MM  
102761-BUCHA NYLON FU 08MM



102395-BUCHA 6MM CANEL  
102396-BUCHA 8MM CANEL



102294-FIXADOR FUNDO



103888 - SUPORTE CABIDEIRO  
CHAPOLIN NIQUELADO



102329 - SUPORTE CABIDEIRO  
SIMPLES CROMADO



102325 - SUPORTE CABIDEIRO DUPLO CROMADO  
102326 - SUPORTE CABIDEIRO DUPLO DOURADO



102339 - SUPORTE PRATELEIRA REDONDO BRANCO  
102340 - SUPORTE PRATELEIRA REDONDO CINZA  
102341 - SUPORTE PRATELEIRA REDONDO MARFIN  
102342 - SUPORTE PRATELEIRA REDONDO MARROM  
102343 - SUPORTE PRATELEIRA REDONDO PRETO

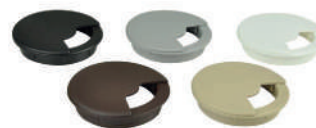

102296-PASSA FIO 25X60 BRANCO  
102297-PASSA FIO 25X60 CEDRO  
102299-PASSA FIO 25X60 CINZA,  
102301-PASSA FIO 25X60 MARFIN  
102303-PASSA FIO 25X60 MARROM  
102306 - PASSA FIO 25X60 PRETO

# SUPORTES



103271 - GANCHO MULTIUSO SIMPLES  
L4 X A65 X P48MM PTO FOSCO



103270 - GANCHO MULTIUSO SIMPLES  
L4 X A65 X P48MM CROMADO



102293 - FECHO ROLETE

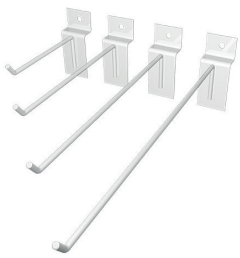

102828-SUPORTE CANALETADO  
BRANCO 100MM  
102830-SUPORTE CANALETADO  
BRANCO 150MM  
102832-SUPORTE CANALETADO  
BRANCO 250MM



102335 - SUPORTE PRATELEIRA  
VIDRO QUADRADO 6MM

102336 - SUPORTE PRATELEIRA  
VIDRO QUADRADO 8MM

102334 - SUPORTE PRATELEIRA  
VIDRO QUADRADO 10MM



102331 - SUPORTE PRATELEIRA  
REDONDO VIDRO 4MM

102332 - SUPORTE PRATELEIRA  
REDONDO VIDRO 6MM

102333 - SUPORTE PRATELEIRA  
REDONDO VIDRO 8MM

102330 - SUPORTE PRATELEIRA  
REDONDO VIDRO 10MM



102337 - SUPORTE P/VIDRO - BOTAO



102344 - SUPORTE P/VIDRO  
ROSCA INTERNA CROMADO



102338 - SUPORTE PINO PRAT 6X8 CROMADO



102157-SUPORTE L 6 FUROS

102158 - CAPA L MARFIM  
102159- CAPA L BRANCO  
102161 - CAPA L GRAFITE  
102162 -CAPA L MARRON



102321-SUPORTE L REFORCADO

102287-CAPA L REFORCADA BRANCO  
102291-CAPA L REFORCADA PRETO  
102288-CAPA L REFORCADA GRAFITE  
102289-CAPA L REFORCADA MARFIN  
102290-CAPA L REFORCADA MARRON  
102292-CAPA L REFORCADA TABACO

# SUPORTES

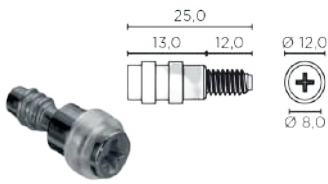

102118-SUPORTE PARAFUSO MINI SP 220

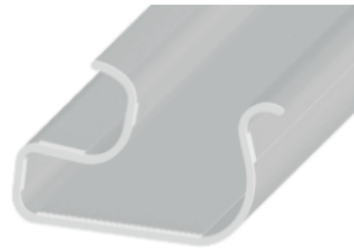

102737 - PERFIL ACAB CANALETADO BRANCO 2,750MT  
 102738 - PERFIL ACAB CANALETADO CINZA 2,750MT  
 102827 - PERFIL ACAB CANALETADO ALUMINIO 2,750MT



102774-SUPORTE UNIBLOK 15MM PLASTMETAL

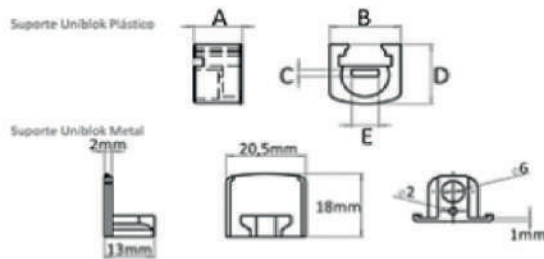

102741-PERFIL DE VEDACAO BRANCO  
 CHANFRADO 100MM

102742-PERFIL DE VEDACAO CURUPIXA  
 CHANFRADO 100MM



103445 -PERFIL DE VEDACAO BRANCO  
 EXTRUSADO BATENTE PORTA

103444 -PERFIL DE VEDACAO CURUPIXA  
 EXTRUSADO BATENTE PORTA



# CABIDEIROS



102322-SUPORTE CABIDEIRO AEREO 90 OBLONGO NIQUELADO



102323-SUPORTE CABIDEIRO CENTRAL OBLONGO CROMADO



102324 -SUPORTE CABIDEIRO CENTRAL REDONDO CROMADO



102327-SUPORTE CABIDEIRO OBLONGO CROMADO



102328 - SUPORTE CABIDEIRO REDONDO CROMADO



102345-TUBO CABIDEIRO CROMADO OBLONGO CURVO 120M



102346-TUBO CABIDEIRO CROMADO OBLONGO CURVO 150MM



102347-TUBO CABIDEIRO CROMADO REDONDO CURVO 120MM



102843-TUBO CABIDEIRO CROMADO OBLONGO 3,0MT

102844-TUBO CABIDEIRO CROMADO REDONDO 3,0MT

102348-TUBO CABIDEIRO CROMADO REDONDO CURVO 150MM

101852 - CABIDEIRO BASC 660-890 PRETO/CROMADO  
101853 - CABIDEIRO BASC 890-1210 PRETO/CROMADO

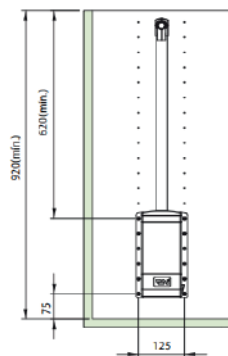
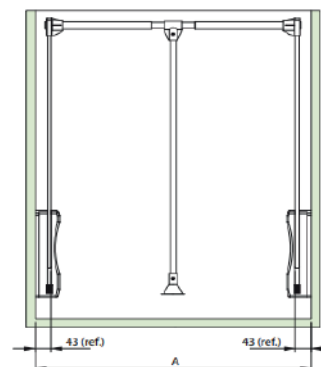

# CORREDICAS E DOBRADIÇAS



102834-DOBRADIÇA  
VAIVEM CROMADA 3

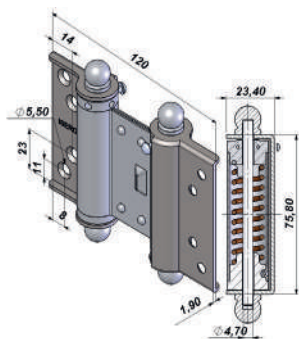

CORTE AA



102835-DOBRADIÇA  
VAIVEM PRETA 3

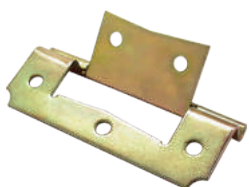

102165-DOBRADIÇA DOBRADA  
F. FIXO 09 ABA



103435-DOBRADIÇA  
RETA 2 F.FIXO ABA



102561-DOBRADIÇA  
PORTA VIDRO 1930



101917-PULSADOR MAGNETICO TN



102985-ARTICULADOR  
AERO PLUS FGVTN



101904-FECHO TOQUE



101914-PISTAO 40N CINZA AMORT - FGVTN  
101915-PISTAO 60N CINZA AMORT - FGVTN  
101916-PISTAO 80N CINZA AMORT - FGVTN  
101912-PISTAO 100N CINZA AMORT - FGVTN  
101913-PISTAO 120N CINZA AMORT - FGVTN



PISTÃO FORÇA NORMAL E INVERSA  
40,60,80,100,120

# DOBRADIÇAS SULFER

Sempre atentos às necessidades dos nossos clientes e nas últimas tendências do mercado, buscamos expandir a nossa marca ainda mais.

Recentemente lançamos a nossa linha completa de dobradiças para portas da melhor qualidade!

Os produtos estão sendo comercializados com uma ampla variedade de acabamentos e tamanhos, para deixar o seu projeto e os móveis do seu lar, ainda mais modernos e seguros.

Conheça toda a variedade de dobradiças da Sulfer e aproveite!



DOBRADIÇAS SULFER

# DOBRADIÇAS

Grande variedade de produtos à pronta entrega.

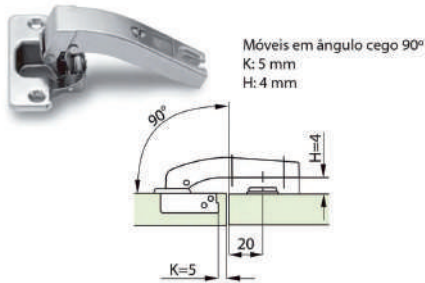

Dobradiça 90 ° ângulo cego

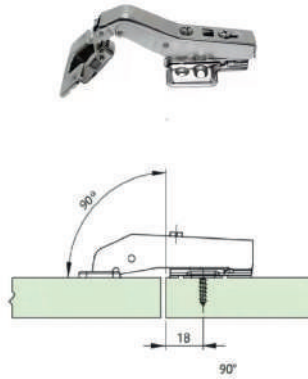

Dobradiça 90 °

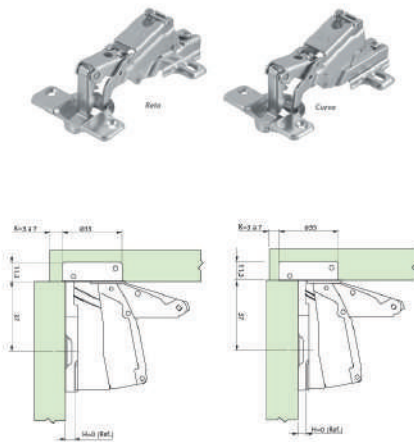

Dobradiça 165°

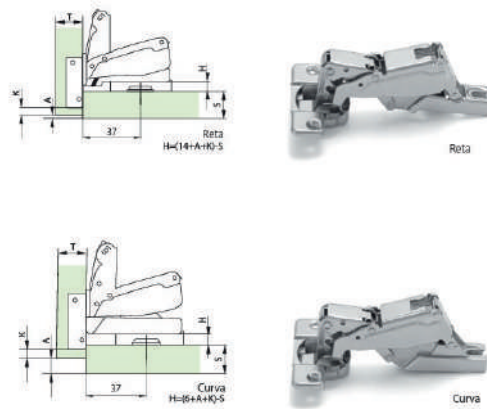

Dobradiça 175°

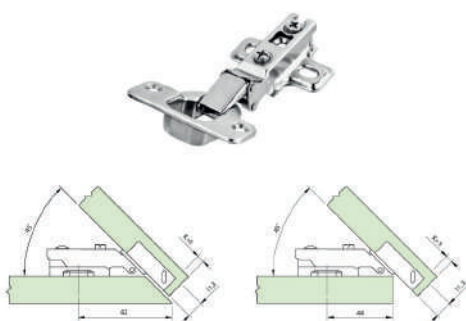

Dobradiça Ângulo -45°

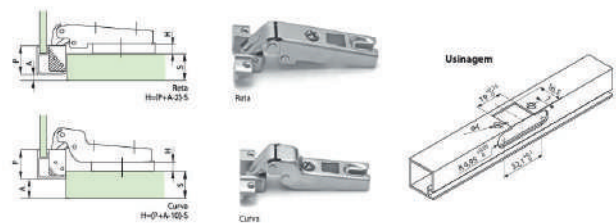

Dobradiça para Alumínio

# CORREDIÇAS SULFER

CORREDIÇAS SULFER



**Sulfer**  
Distribuidora

400R

Sulfer



TRILHO  
TELESCÓPICO  
LARGO

**Sulfer**  
Distribuidora

# CORREDIÇAS

Grande variedade de produtos à pronta entrega.

- ✓ Branca
- ✓ Telescópica
- ✓ Com amortecedor
- ✓ Invisível com amortecedor
- ✓ Várias medidas



# DIVISORES



102215-DIVISOR CONCHA 3D MAX  
380X475MM MIN 305X390MM

102217-DIVISOR CONCHA 3D PRATA MAX  
380X475MM MIN 305X395MM



102228-DIVISOR TALHERES 6D  
MAX 380X475MM MIN 305X390MM

102231 - DIVISOR TALHERES 6D PRATA H65  
MAX: 380X475MM MIN: 305X390MM

102229 - DIVISOR TALHERES 6D  
MAX: 430X510MM MIN: 345X440MM

102232 - DIVISOR TALHERES 6D PRATA H65  
MAX: 430X510MM MIN: 345X440MM



102233-DIVISOR TALHERES 7D MAX  
565X495MM MIN 505X425MM



102230-DIVISOR TALHERES 6D  
MAX 565X495MM MIN 508X440MM



102224-DIVISOR TALHERES 12D  
MAX 775X490MM  
MIN 590X425MM



102227-DIVISOR TALHERES 5D  
MAX 290X420MM  
MIN 245X355MM



102226-DIVISOR TALHERES 4D  
MAX 380X475MM  
MIN 305X390MM

# DIVISORES



102225-DIVISOR TALHERES 15D  
MAX 970X510MM  
MIN 885X430MM



102222 - DIVISOR TALHERES 11D  
MAX: 685X495MM  
MIN: 595X425MM



102220-DIVISOR P/ NOTAS 14D  
MAX 510X420MM  
MIN 485X385MM



102218-DIVISOR P/ NOTAS 11D  
MAX 440X260MM  
MIN 420X250MM



102219-DIVISOR P/ NOTAS 12D  
MAX 510X330MM  
MIN 488X295MM



103249-BANDEJA FLOCADA PRETA PARA JOIAS  
20D 400X300MM



102234 -PORTA NOTAS E MOEDAS  
C/PRENDEDOR DE CELULAS 510X330



# PÉ E RODÍZIOS

# PÉS E RODÍZIOS



102308-PÉ PLÁSTICO BRANCO 130MM  
REDONDO C/ REGULAGEM



102312-PÉ PLÁSTICO PRETO 130MM  
REDONDO C/ REGULAGEM



102310-PÉ PLÁSTICO CINZA 130MM  
REDONDO C/ REGULAGEM



102309-PÉ PLÁSTICO BRANCO 130MM  
BASE QUADRADA REGULAGEM



102313-PÉ PLÁSTICO PRETO 130MM  
BASE QUADRADA REGULAGEM



102311-PÉ PLÁSTICO CINZA 130MM  
BASE QUADRADA REGULAGEM



- 101546 - PÉ REDONDO 100 MM CROMADO
- 101547 - PÉ REDONDO 150 MM CROMADO
- 103840 - PÉ REDONDO 100 MM BRANCO
- 103841 - PÉ REDONDO 150 MM BRANCO
- 103838 - PÉ REDONDO 100 MM PRETO
- 103839 - PÉ REDONDO 150 MM PRETO



- 101544 - PÉ QUADRADO 100 MM CROMADO
- 101545 - PÉ QUADRADO 150 MM CROMADO
- 103842 - PÉ QUADRADO 100 MM BRANCO
- 103843 - PÉ QUADRADO 150 MM BRANCO
- 103844 - PÉ QUADRADO 100 MM PRETO
- 103845 - PÉ QUADRADO 150 MM PRETO



- 103854 - PE CONICO 100 MM CROMADO
- 103855- PE CONICO 120 MM CROMADO
- 103856 - PE CONICO 150 MM CROMADO
- 103859 - PE CONICO 100 MM BRANCO
- 103858 - PE CONICO 120 MM BRANCO
- 103857 - PE CONICO 150 MM BRANCO

# PÉ E RODÍZIOS



101565-RODIZIO SILICONE 35MM  
C/FREIO  
P75XA50XL40MM 30KG



101566-RODIZIO SILICONE 35MM  
S/FREIO  
P75XA50XL40MM 30KG



101567-RODIZIO SILICONE 50MM  
C/FREIO  
P75XA65XL40MM 40KG



102244-RODIZIO SILICONE 50MM  
S/FREIO  
P75XA65XL40MM 40KG



102245-RODIZIO SILICONE 75MM  
C/FREIO  
P110XA95XL60MM 40KG



102246-RODIZIO SILICONE 75MM  
S/FREIO  
P110XA95XL60MM 40KG



102970-RODIZIO NEOO  
C/FREIO  
100MM FGVTN



102979- RODIZIO RG50 INCOLOR  
FIXO TOTAL  
65MM

102974-RODIZIO NEOO  
S/FREIO  
100MM FGVTN



103474- RODIZIO RG75  
C/ ROLAMENTO INC.CR.  
S/ FREIO TOTAL  
95MM

102982- RODIZIO RG75  
C/ROLAMENETO INC.CR.  
C/FREIO TOTAL  
95MM



103471- RODIZIO RG35 INCOLOR SEM FREIO TOTAL 50MM  
102983- RODIZIO RG35 INCOLOR COM FREIO TOTAL 50MM  
103396- RODIZIO RG50 INCOLOR SEM FREIO TOTAL 65MM  
103472- RODIZIO RG50 INCOLOR COM FREIO TOTAL 65MM  
103473- RODIZIO RG75 INCOLOR COM FREIO TOTAL 95MM  
102980- RODIZIO RG75 INCOLOR SEM FREIO TOTAL 95MM  
102981- RODIZIO RG100 INCOLOR COM FREIO TOTAL 125MM  
103470- RODIZIO RG100 INCOLOR SEM FREIO TOTAL 125MM

# PUXADORES



101554-PUXADOR HASTE QUADRADO POLIDO 128/200M

101555-PUXADOR HASTE QUADRADO POLIDO 160/250M

101556-PUXADOR HASTE QUADRADO POLIDO 256/400M



101560-PUXADOR HASTE REDONDO 12 POLIDO 96/150MM

101558-PUXADOR HASTE REDONDO 12 POLIDO 128/200MM

101559-PUXADOR HASTE REDONDO 12 POLIDO 256/400MM



101561-PUXADOR PONTO 24MM CROMADO, 101562-PUXADOR PONTO 31,5MM CROMADO



101563-PUXADOR PONTO 22X19 QUADRADO CROMADO

101564-PUXADOR PONTO 30X23,2 QUADRADO CROMADO



102319 - PUXADOR 100MM SERRALHEIRO CROMADO



102698-PUXADOR 96MM PRINCFENIX 102697-PUXADOR 128MM PRINCFENIX



103163-PUXADOR BEETLE COM BASE GRANADA NIQUEL VELHO



103175-PUXADOR BEETLE COM BASE GRANADA DOURADO - ZEN

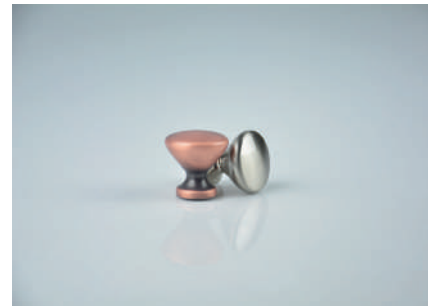

103165 - PUXADOR PONTO CUP NIQUEL VELHO  
103166 - PUXADOR PONTO CUP VECCHIO COBRE  
103164 - PUXADOR PONTO CUP DOURADO



103168-PUXADOR PLYMOUTH 80MM PRETO - ZEN



103244-PUXADOR PLYMOUTH 80 DOURADO - ZEN



103167 - PUXADOR PLYMOUTH 80MM NIQUEL VELHO - ZEN



103176-PUXADOR ANTIQUE VECCHIO COBRE - ZEN



103178-PUXADOR ANTIQUE DOURADO - ZEN



103170-PUXADOR SHELL 64MM  
648 VECCHIO COBRE - ZEN



103171-PUXADOR SHELL 64MM  
889 NIQUEL VELHO - ZEN



103172-PUXADOR SHELL 64MM  
955 DOURADO - ZEN

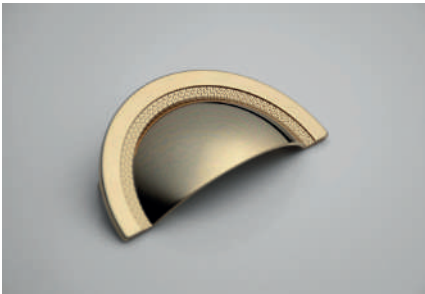

103173-PUXADOR SHELL  
64MM GOLD - ZEN



103174-PUXADOR SHELL  
64MM ROSE - ZEN



103245-PUXADOR BALI GRANADO  
PONTO GOLD - ZEN



103246-PUXADOR BALI GRANADO  
PONTO DOURADO - ZEN

# FERRAGENS E FECHADURAS

102111-DESEMPENADOR ALINHADOR DE PORTAS DP-90 SOBREPOR

## DP 90

Desempenador de Porta

### Características

- Distância de fixação em relação a lateral da porta:  
Largura da porta X 15% = Local da aplicação
- Espessura mínima de 15mm
- Sistema Sobreposto

**IMPORTANTE:** Para portas com mais de 700 mm de largura utilizar 2 desempenadores.

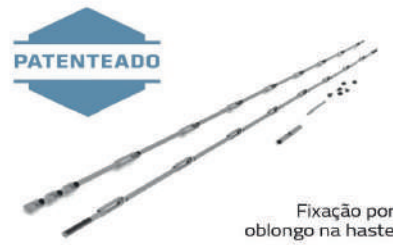

Fixação por oblongo na haste

### Componentes | Kit para 01 porta

Imagem	Código	Peças
	Haste	4
	Regulador Central	2
	Chave de Regulagem	1
	Parafusos	-

A espessura total do desempenador é de 7 mm. O espaçamento entre as portas deve ser de no mínimo 10 mm. Para portas com mais de 2100 mm de altura.

### Montagem

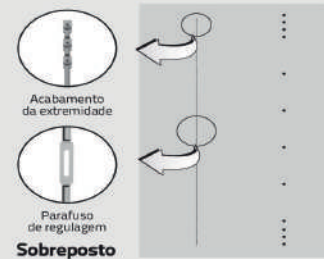

Tamanho total do DP 90 aproximado: 2000 mm

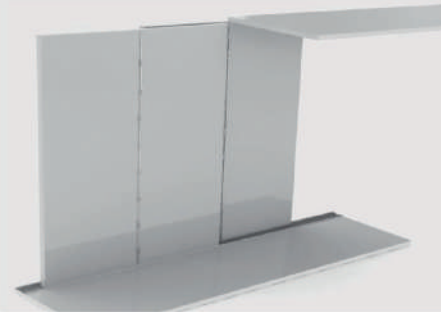

102110-DESEMPENADOR ALINHADOR DE PORTAS DE CORRER DP-10

## DP 100/101

Desempenador de Porta

### Características

- Espessura mínima de 15mm
- Sistema Embutido

**IMPORTANTE:** Para portas com mais de 700 mm de largura utilizar 2 desempenadores.



### Aplicações



### Componentes | Kit para 01 porta

Imagem	Código	Peças
	Haste de alumínio	4
	Regulador Central	2
	Presilha	12
	Tampas Superiores	2
	Tampas Inferiores	2
	Acabamentos Centrais	2
	Chave de Regulagem	1
	Parafusos	-

### Montagem

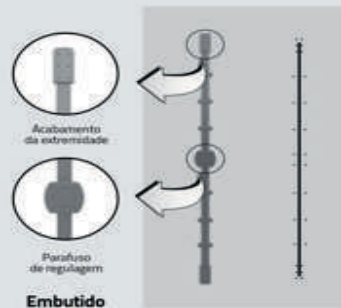

# FERRAGENS E FECHADURAS



102691-KIT P/PORTA 2 MT 2 RODAS CONCAVA  
102692-KIT P/PORTA 2 MT 4 RODA CONCAVA



102694-KIT ROLDANAS 2 RODA CONCAVA



102695-KIT ROLDANAS 4 RODA CONCAVA



102693-GUIA 9MM RETA

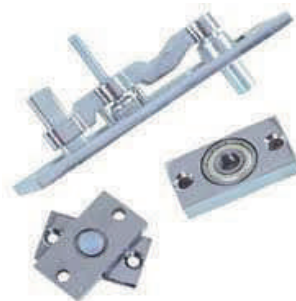

103849 -PINO PIVOTANTE ISERO Z

# FERRAGENS E FECHADURAS

102965-CORREDICA TT10/302 480X800MM BRANCO

**Descrição:** Ferragem telescópica de grande curso, com deslizamento através de esferas de aço, para tampos dobráveis em duas folhas.

**Material:** Aço relaminado estrutural

**Acabamento:** Pintura epóxi pó branco ou cinza cromo

**Fixação:** Lateral e apoiada com parafusos Fixer 3,5 mm cabeça panela

**Capacidade:** 80 kg (sem utilização de pés)

**Embalagem:** 1 par por caixa

**Observações:** Acompanha kit com calços para nivelamento e travamento da mesa, dobradiças invisíveis e parafusos para instalação - Largura máxima recomendada 900 mm.



Código	Descrição	Embalagem
0072.972062	TT 10/302 480 x 800 mm Branco	1 par/caixa
0072.972063	TT 10/302 480 x 800 mm Cinza Cromo	1 par/caixa

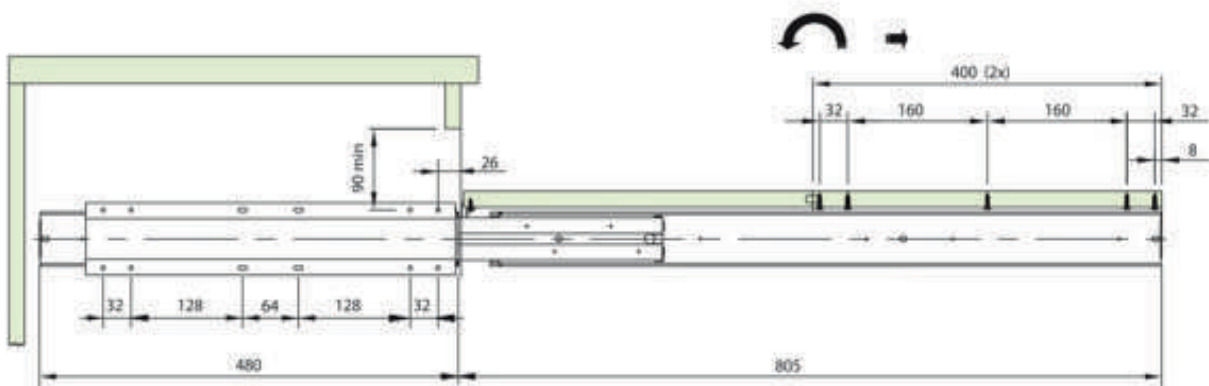
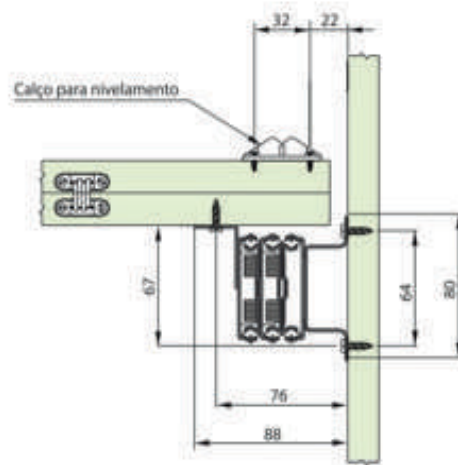



# FERRAGENS E FECHADURAS



102565-FECHADURA P/GAVETA 22MM  
102566-FECHADURA P/GAVETA 31MM



102567-FECHADURA 2421  
PRESSAO P/PORTA CORRER 39 23MM  
CROMADO



102563-FECHADURA TUBOLAR  
P/ PORTA DIVISORIA  
PRETA



102254-FECHADURA  
P/PORTA PIVOTANTE STAM

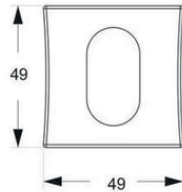
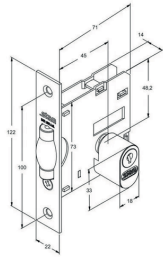

102562 - FECHADURA 0202  
P/PORTA CORRER 22MM CROMADO



102559-BATENTE P/FECHADURA  
LINGUETA GAVETA



102564-FECHADURA TUBOLAR  
P/ PORTA DIVISORIA  
CROMADA



102253-FECHADURA P/PORTA CORRER STAM

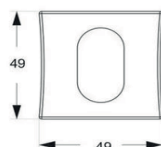
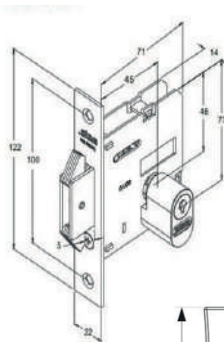

103405 -FECHADURA PORTA CORRER  
EXT CROMADO ROS37

# PINOS E PARAFUSOS

PARAFUSO FLANGEADO 4.2X13  
 PARAFUSO FLANGEADO 3.5X16  
 PARAFUSO FLANGEADO 3.5X20  
 PARAFUSO FLANGEADO 3.5X20  
 PARAFUSO CHIPBOARD 3.0X14  
 PARAFUSO CHIPBOARD 3.0X16  
 PARAFUSO CHIPBOARD 3.0X25  
 PARAFUSO CHIPBOARD 3.0X30  
 PARAFUSO CHIPBOARD 3.5X12  
 PARAFUSO CHIPBOARD 3.5X14  
 PARAFUSO CHIPBOARD 3.5X16  
 PARAFUSO CHIPBOARD 3.5X20  
 PARAFUSO CHIPBOARD 3.5X22  
 PARAFUSO CHIPBOARD 3.5X25  
 PARAFUSO CHIPBOARD 3.5X25  
 PARAFUSO CHIPBOARD 3.5X25  
 PARAFUSO CHIPBOARD 3.5X30  
 PARAFUSO CHIPBOARD 3.5X35  
 PARAFUSO CHIPBOARD 3.5X40  
 PARAFUSO CHIPBOARD 4.0X14  
 PARAFUSO CHIPBOARD 4.0X16  
 PARAFUSO CHIPBOARD 4.0X20  
 PARAFUSO CHIPBOARD 4.0X25  
 PARAFUSO CHIPBOARD 4.0X30  
 PARAFUSO CHIPBOARD 4.0X35  
 PARAFUSO CHIPBOARD 4.0X40  
 PARAFUSO CHIPBOARD 4.0X45  
 PARAFUSO CHIPBOARD 4.0X50  
 PARAFUSO CHIPBOARD 4.5X16  
 PARAFUSO CHIPBOARD 4.5X20  
 PARAFUSO CHIPBOARD 4.5X25  
 PARAFUSO CHIPBOARD 4.5X30  
 PARAFUSO CHIPBOARD 4.5X35  
 PARAFUSO CHIPBOARD 4.5X40  
 PARAFUSO CHIPBOARD 4.5X45  
 PARAFUSO CHIPBOARD 4.5X50  
 PARAFUSO CHIPBOARD 4.5X60  
 PARAFUSO CHIPBOARD 5.0X30  
 PARAFUSO CHIPBOARD 5.0X40  
 PARAFUSO CHIPBOARD 5.0X45  
 PARAFUSO CHIPBOARD 5.0X50  
 PARAFUSO CHIPBOARD 5.0X60  
 PARAFUSO CHIPBOARD 5.0X80  
 PARAFUSO CHIPBOARD 6.0X60  
 PARAFUSO CHIPBOARD 6.0X70  
 PARAFUSO CHIPBOARD 6.0X90



PARAFUSO CHIPBOARD 3.5X16 MASTER  
 PARAFUSO CHIPBOARD 3.5X20 MASTER  
 PARAFUSO CHIPBOARD 3.5X30 MASTER  
 PARAFUSO CHIPBOARD 3.5X35 MASTER  
 PARAFUSO CHIPBOARD 3.5X40 MASTER  
 PARAFUSO CHIPBOARD 4.0X16 MASTER  
 PARAFUSO CHIPBOARD 4.0X20 MASTER  
 PARAFUSO CHIPBOARD 4.0X25 MASTER  
 PARAFUSO CHIPBOARD 4.0X30 MASTER  
 PARAFUSO CHIPBOARD 4.0X35 MASTER  
 PARAFUSO CHIPBOARD 4.0X40 MASTER  
 PARAFUSO CHIPBOARD 4.0X45 MASTER  
 PARAFUSO CHIPBOARD 4.0X50 MASTER  
 PARAFUSO CHIPBOARD 4.5X16 MASTER  
 PARAFUSO CHIPBOARD 4.5X20 MASTER  
 PARAFUSO CHIPBOARD 4.5X25 MASTER  
 PARAFUSO CHIPBOARD 4.5X30 MASTER  
 PARAFUSO CHIPBOARD 4.5X40 MASTER

PARAFUSO FLANGEADO 4.2X13 PONTA BROCA

PARAFUSO CHIPBOARD 4.0X35 PONTA BROCA  
 PARAFUSO CHIPBOARD 4.0X40 PONTA BROCA  
 PARAFUSO CHIPBOARD 4.0X45 PONTA BROCA



101242- PARAFUSO CAMA  
FEND C/ PORCAX 5/16 - 120MM

# GRAMPOS

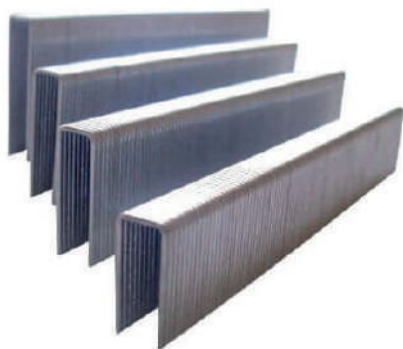

- 102177 - GRAMPO GALVANIZADO 8004 - FILETTO
- 102178 - GRAMPO GALVANIZADO 8006 - FILETTO
- 102179 - GRAMPO GALVANIZADO 8008 - FILETTO
- 102180 - GRAMPO GALVANIZADO 8010 - FILETTO
- 102181 - GRAMPO GALVANIZADO 8012 - FILETTO
- 102182 - GRAMPO GALVANIZADO 8014 - FILETTO
- 102183 - GRAMPO GALVANIZADO 8016 - FILETTO



- 102177 - GRAMPO GALVANIZADO 8004 - FILETTO
- 102178 - GRAMPO GALVANIZADO 8006 - FILETTO
- 102179 - GRAMPO GALVANIZADO 8008 - FILETTO
- 102180 - GRAMPO GALVANIZADO 8010 - FILETTO
- 102181 - GRAMPO GALVANIZADO 8012 - FILETTO
- 102182 - GRAMPO GALVANIZADO 8014 - FILETTO
- 102183 - GRAMPO GALVANIZADO 8016 - FILETTO

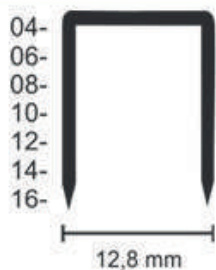

# ABRASIVOS



102051 - LIXA ESPUMA GR220  
102051 - LIXA ESPUMA METRO LARG 115 X GR 220



102057 - LIXA PANO LARG 120MM GR60  
102978 - LIXA PANO LARG 150MM GR120



102058 - LIXA PAPEL METRO LARG 115 GR 060  
103769 - LIXA PAPEL METRO LARG 115 X GR 080  
103179 - LIXA PAPEL METRO LARG 115 LARG GR100  
103777 - LIXA PAPEL METRO LARG 115 X GR 120



LIXA CORREIA

102041 - GR060 115 X 6900  
102042 - GR060 115 X 7200

102043 - GR080 115 X 6900  
102044 - GR080 115 X 7200

102039 - GR100 115 X 6900  
102040 - GR100 115 X 7200



LIXA CORREIA 341 DL

102046 -GR60 75 X 610  
102047 - GR060 75 X 530  
102048 - GR060 75 X 610  
102049 - GR080 75 X 530  
103510- GR80 75 X 610  
103511 - GR100 75 X 610



102056 - FRECUT P320 FL  
102052 - LIXA FOLHA 215M P100A FL 225X275  
102055 - LIXA FOLHA 234U P120A FL 225X275  
102053 - LIXA FOLHA 215N P150A FL 225X275  
102054 - LIXA FOLHA 215N P220A FL 225X275  
103506 - LIXA FOLHA GR400 225 X 275 215N  
102056 - LIXA FOLHA FRECUT P320 FL 225X275



102977 - FITA DUPLA FACE  
TRANSP 09MMX33MTS



102438 - FITA CREPE BRANCA 18X50MT  
102439 - FITA CREPE 48MMX50MT



102437 - FITA ADESIVA  
TRANSPARENTE 48X50MT

# COLAS E QUÍMICOS



102168-COLA ALMASUPER 100G



102173-KIT COLA ALMASUPER KIT MDF



102167-COLA ALMASUPER SPRAY 190 ML



101943-COLA GRANULADA JOWAT BRANCO  
ALTA TEMP ARTEMELT

101944-COLA GRANULADA INCOLOR  
ALT TEMP ARTEMELT

TEMPERATURA DE TRABALHO  
DE 180° A 200° GRAUS



102137 - COLA GRANULADA BRANCO

102136-COLA GRANULADA INCOLOR  
BAIXA TEMPERATURA

TEMPERATURA DE TRABALHO  
DE 140° A 160° GRAUS



103835- COLA GRANULADA

1807 TRANSP BALDE 2,3 KG  
103836-COLA GRANULADA 1808  
BRANCA BALDE 2,5 KG

TEMPERATURA DE TRABALHO  
DE 140° A 160° GRAUS



103402-KIT CORRECAO SULPEN 20 GIZES



102092 - COLA FORMICA LATA 0,750KG

102094 - COLA FORMICA LATA 2,8KG

102093 - COLA FORMICA LATA 14KG



103238-THINNER FARBEN 1570 5LT

103441-THINNER FARBEN 1570 18LT



103760-COLA ADESIVO FRANK TB II  
PREMIUM WOOD GLUE 258G

103761-COLA ADESIVO FRANK TB II  
PREMIUM WOOD GLUE 516G



103762-COLA ADESIVO FRANK TB III  
ULTIMATE WOOD GLUE 263G

103763-COLA ADESIVO FRANK TB III  
ULTIMATE WOOD GLUE 525G

# COLAS E QUÍMICOS



103751-FIXA ESPELHO BRANCO  
UNIPEGA CART 280ML



102169-COLA HT 400



102776-COLA LIQUIDA  
PUR 500 KLEIBERIT

103645-COLA LIQUIDA  
PUR 1 KG KLEIBERIT



103850 - SILICONE ADESIVO BRANCO  
BASE D AGUA 450G UNIPEGA



102851 -SILICONE  
ADESIVO INCOLOR 280ML



102170-COLA BRANCA 1KG  
102172-COLA BRANCA 5KG  
102171-COLA BRANCA 10KG



# CUBAS E VÁLVULAS

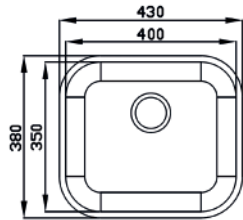

102141-CUBA INOX N3 400X350X140MM  
POLIDA FURO N3

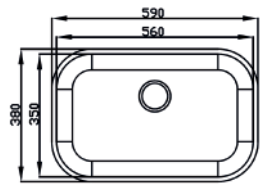

102139-CUBA INOX N2  
560X350X140MM POLIDA FURO N3

102142- CUBA INOX N3 400X350X170MM  
POLIDA FURO N4

,102140-CUBA INOX N2  
560X350X170MM POLIDA FURO N4

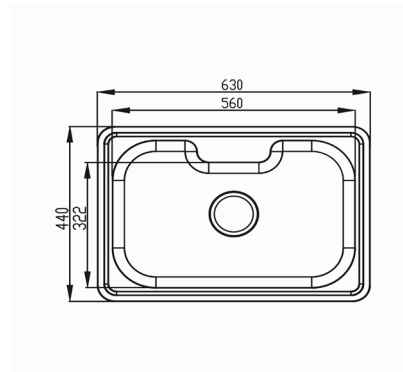

103443-CUBA PREMIUM 630X440X200

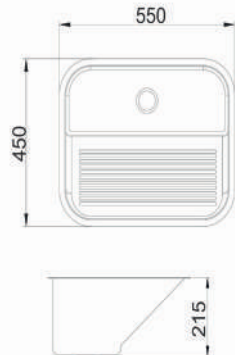

102145-TANQUE SOBREPOR  
550X450X250MM 30LT

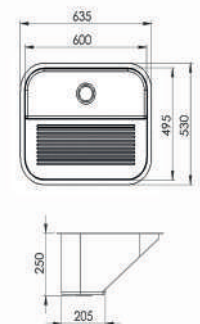

102146-TANQUE SOBREPOR  
635X530X250MM 55LT

# CUBAS E VÁLVULAS



102144-LIXEIRA MULTIUSO REDONDA  
EMB. TAMPA INOX 5L

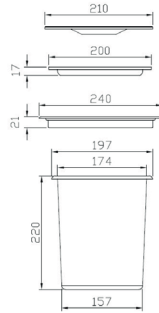

102147-VALVULA N3 CROMADA

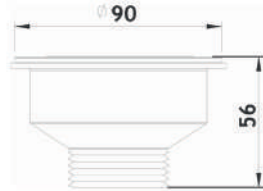

102148-VALVULA N4 CROMADA

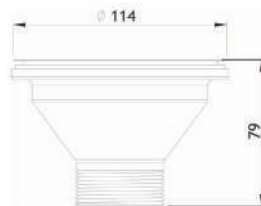

102143-DOSADOR PDETERGENTE 350ML

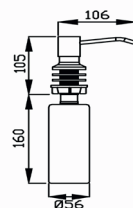



# PERFIS

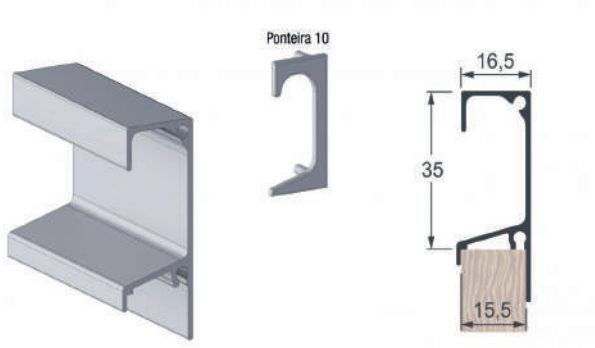

101979-PERFIL ALUM PUX 5046T 15MM ANOD  
101980-PERFIL ALUM PUX 5046T 15MM INOX

102271-ACAB PONT LAT 5046T 15MM ANOD  
102272-ACAB PONT LAT 5046T 15MM INOX

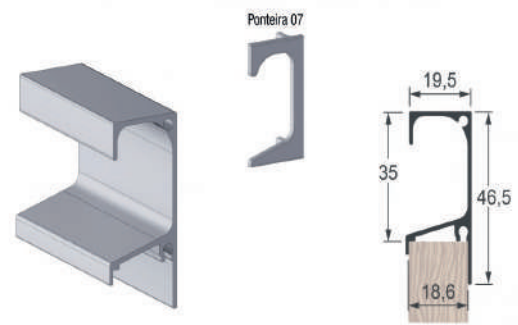

101982-PERFIL ALUM PUX 5047T 18MM ANOD  
101983-PERFIL ALUM PUX 5047T 18MM INOX

102273-ACAB PONT LAT 5047T 18MM ANOD  
102274-ACAB PONT LAT 5047T 18MM INOX

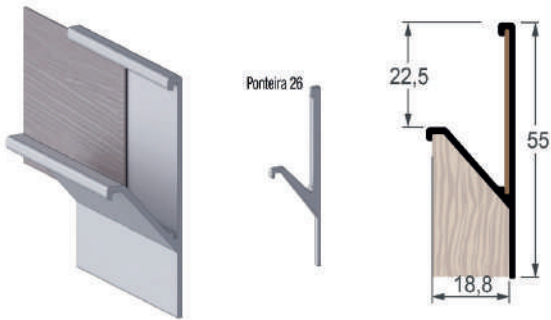

101993-PERFIL ALUM PUX 4023 18MM ANOD  
101994-PERFIL ALUM PUX 4023 18MM INOX  
101949-ACAB PONT LAT 4023 18MM ANOD  
101950-ACAB PONT LAT 4023 18MM INOX

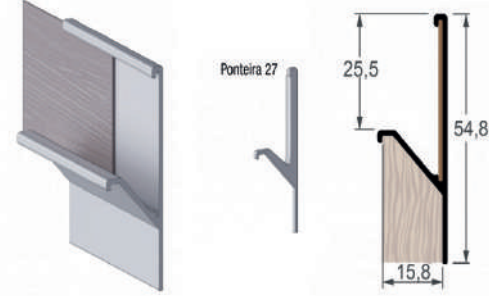

101995,PERFIL ALUM PUX 4025 15MM ANOD  
101996-PERFIL ALUM PUX 4025 15MM INOX  
101951-ACAB PONT LAT 4025 15MM ANOD  
101952-ACAB PONT LAT 4025 15MM INOX

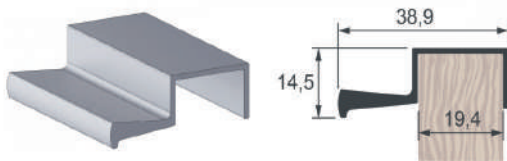

101966-PERFIL ALUM PUX 2009 18MM INOX,  
102014-PERFIL ALUM PUX 2009 18MM ANOD

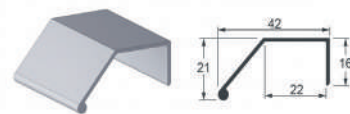

101968-PERFIL ALUM PUX 2015 ANOD  
101969-PERFIL ALUM PUX 2015 INOX

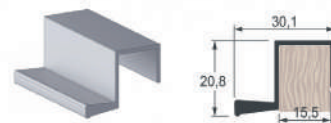

101986-PERFIL ALUM PUX 2008 INOX ,  
101987-PERFIL ALUM PUX 2008 ANOD

# PERFIS

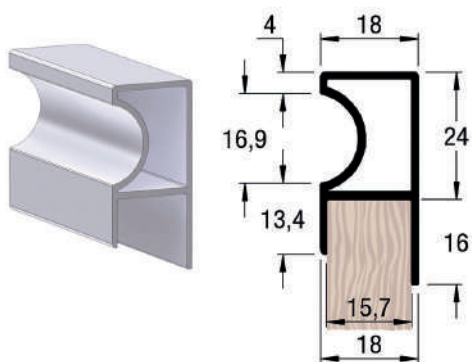

101991-PERFIL ALUM PUX 4003 15MM ANOD

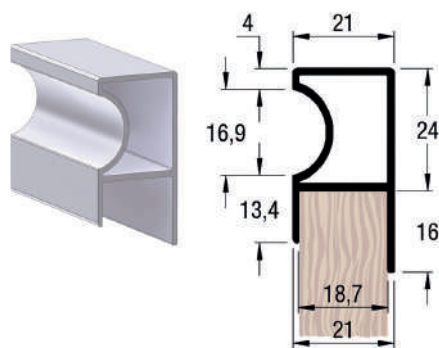

101992-PERFIL ALUM PUX 4004 18MM ANOD



102025-PERFIL TRILHO INF 2050 15MM ANOD,  
102028-PERFIL TRILHO INF 2050 15MM INOX

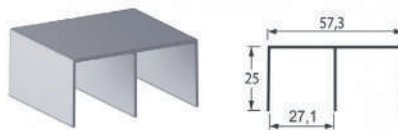

102026-PERFIL TRILHO SUP 2055 15MM ANOD  
102032-PERFIL TRILHO SUP 2055 15MM INOX



102027-PERFIL TRILHO INF 2052 18MM ANOD  
102029-PERFIL TRILHO INF 2052 18MM INOX

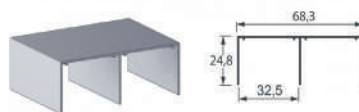

102030-PERFIL TRILHO SUP 2057 18MM INOX  
102031-PERFIL TRILHO SUP 2057 18MM ANOD

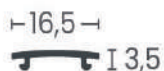
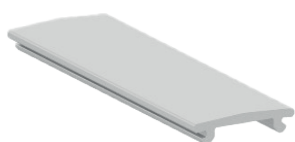

101961 - PERFIL DIFUSOR  
03R ACRILICO PARA LED 3MT

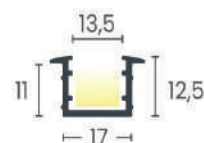

101984 - PERFIL ALUM LED  
02 ANOD 6MT - ALTERNATIVA

101985 - PERFIL ALUM LED  
02 INOX 6MT - ALTERNATIVA

# PERFIS

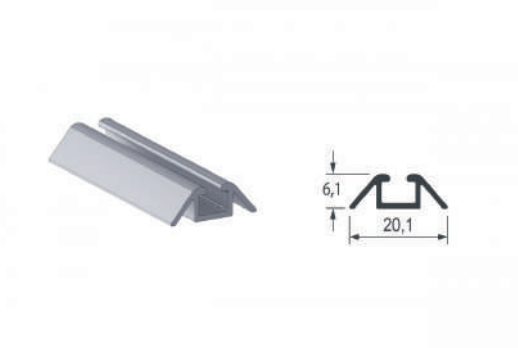

102033-PERFIL TRILHO INF 2051 ANOD  
102034-PERFIL TRILHO INF 2051 INOX

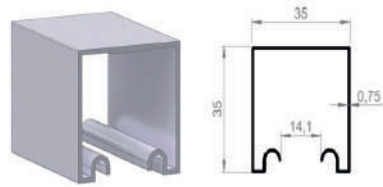

103398-PERFIL TRILHO SUPERIOR P ABERTURAS



102314 -PERFIL ALUM EMBUTIR 23-003 - 3 MTS



102275 -ACAB PONT LAT 23-003 15MM CROMADO

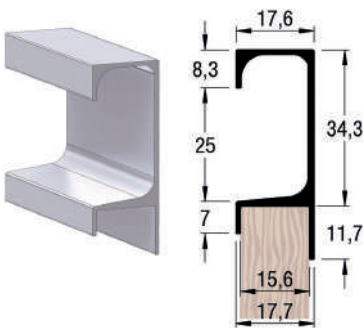

103418-PERFIL ALUM PUX 5046 ANOD 6MT

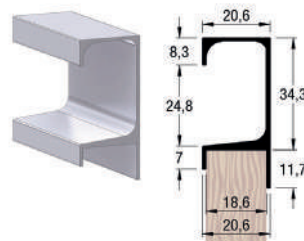

103419-PERFIL ALUM PUX 5047 18MM ANOD



102024 - PERFIL TRILHO INF 2053 ANOD 6MT

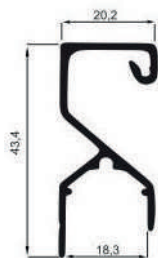

102755-PERFIL ALUM PUX 4125 15MM ANOD 6MT - RFC  
102757-PERFIL ALUM PUX 4128 18MM ANOD 6MT - RFC  
102269-ACAB PONT LAT 4125 15MM ANOD - RFC  
102270-ACAB PONT LAT 4128 18MM ANOD - RFC

102756-PERFIL ALUM PUX 4125 15MM INOX 6MT - RFC  
102758-PERFIL ALUM PUX 4128 18MM INOX 6MT - RFC  
102267-ACAB PONT LAT 4125 15MM INOX - RFC  
102268-ACAB PONT LAT 4128 18MM INOX - RFC

103864 - PERFIL PUXADOR 4125 15MM PRETO 6,0MT RFC  
103865 - PERFIL PUXADOR 4128 18MM PRETO 6,0MT RFC  
103866 - ACAB PONT LAT 4125 15MM PRETO - RFC  
103867 - ACAB PONT LAT 4128 18MM PRETO - RFC

## PERFIS

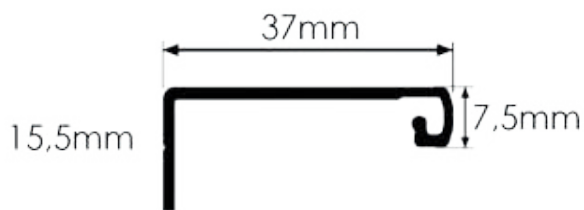

- 103807 - PERFIL PUXADOR FACETATO RM-183 TITANIO 6MT ROMETAL
- 103808 - PERFIL PUXADOR FACETATO RM-183 INOX MATE ESCURO 6MT ROMETAL
- 103809 - PERFIL PUXADOR FACETATO RM-183 ANODIZADO 6MT ROMETAL



- 103810 - ACAB PONT LAT 10781 FACETATO DIR/ESQ 15MM TITANIO
- 103811 - ACAB PONT LAT 10781 FACETATO DIR/ESQ 15MM CROMO ACETINADO
- 103812 - ACAB PONT LAT 10781 FACETATO DIR/ESQ 15MM INOX MATE ESCURO
- 103813 - ACAB PONT LAT 10781 FACETATO DIR/ESQ 15MM CROMO BRILHO
- 103814 - ACAB PONT LAT 10782 FACETATO DIR/ESQ 18MM TITANIO
- 103815 - ACAB PONT LAT 10782 FACETATO DIR/ESQ 18MM CROMO ACETINADO
- 103816 - ACAB PONT LAT 10782 FACETATO DIR/ESQ 18MM INOX MATE ESCURO
- 103817 - ACAB PONT LAT 10782 FACETATO DIR/ESQ 18MM CROMO BRILHO



- 103818- ACAB PONT LAT 11257 FACETATO DIR/ESQ RETA 15MM TITANIO
- 103819 - ACAB PONT LAT 11257 FACETATO DIR/ESQ RETA 15MM CROMO ACETINADO
- 103820 - ACAB PONT LAT 11257 FACETATO DIR/ESQ RETA 15MM INOX MATE ESCURO
- 103821 - ACAB PONT LAT 11257 FACETATO DIR/ESQ RETA 15MM CROMO BRILHO
- 103822 - ACAB PONT LAT 11258 FACETATO DIR/ESQ RETA 18MM TITANIO
- 103823 - ACAB PONT LAT 11258 FACETATO DIR/ESQ RETA 18MM CROMO ACETINADO
- 103824 - ACAB PONT LAT 11258 FACETATO DIR/ESQ RETA 18MM INOX MATE ESCURO
- 103825 - ACAB PONT LAT 11258 FACETATO DIR/ESQ RETA 18MM CROMO BRILHO

# PERFIS



- 103826 - ACAB PONT LAT 11266 FACETATO DIR/ESQ 15MM TITANIO
- 103827 - ACAB PONT LAT 11266 FACETATO DIR/ESQ 15MM CROMO ACETINADO
- 103828 - ACAB PONT LAT 11266 FACETATO DIR/ESQ 15MM INOX MATE ESCURO
- 103829 - ACAB PONT LAT 11266 FACETATO DIR/ESQ 15MM CROMO BRILHO
- 103830 - ACAB PONT LAT 11267 FACETATO DIR/ESQ 18MM TITANIO
- 103831 - ACAB PONT LAT 11267 FACETATO DIR/ESQ 18MM CROMO ACETINADO
- 103832 - ACAB PONT LAT 11267 FACETATO DIR/ESQ 18MM INOX MATE ESCURO
- 103833- ACAB PONT LAT 11267 FACETATO DIR/ESQ 18MM CROMO BRILHO

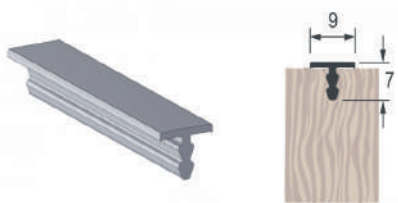

- 102006-PERFIL ALUM TESTEIRA 2029 ANOD,
- 103440-PERFIL ALUM TESTEIRA 2029 INOX

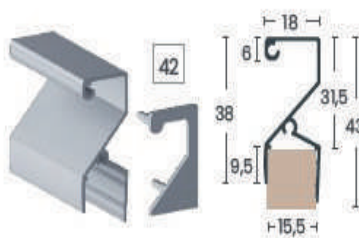

- 103880 - PERFIL ALUM PUX 8007 15MM ANOD 6MT - ALTERNATIVA
- 103457 - PERFIL ALUM PUX 8007 15MM INOX 6MT - ALTERNATIVA
- 103881 - ACAB PONT PF8007 15MM ANOD ALTERNATIVA
- 103458 - ACAB PONT PF8007 15MM INOX ALTERNATIVA

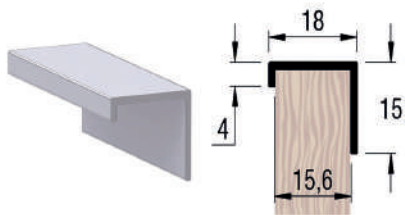

- 101970 - PERFIL ALUM TESTEIRA 2024 15MM ANOD

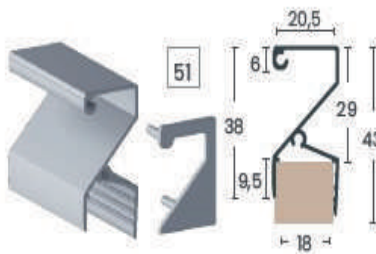

- 103883 - PERFIL PUX 8008 18MM ANOD 6MT - ALTERNATIVA
- 103882 - PERFIL PUX 8008 18MM INOX FENDI BRIL 6MT - ALTERNATIVA
- 103885 - ACAB PONT 8008 18MM ANOD ALTERNATIVA
- 103884 - ACAB PONT 8008 18MM INOX FENDI BRIL ALTERNATIVA

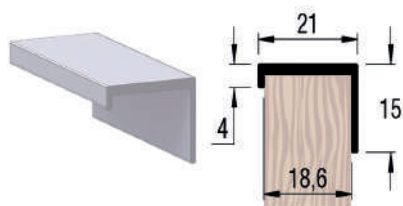

- 101971 - PERFIL ALUM TESTEIRA 2025 18MM ANOD 6MT

# SISTEMA DE CORRER

102019-SISTEMA DE CORRER AL 60 COM GUIA AUTO AJUSTAVEL - ALTERNATIVA



**ALTERNATIVA**  
MANUAL DE INSTRUÇÕES AL 60 REV. 01 07/2022

**ROLDANA AL 60**  
x2

**GUIAS x2**  
VERIFICAR O MODELO DA GUIA NA EMBALAGEM

**FREIO PADRÃO**  
x2

**PARAFUSOS PHILIPS**  
CABEÇA CHATA (3,5x25mm) x2  
FLANGEADO (3,5x14mm) x8  
FLANGEADO (3,5x20mm) x4

**DESCONTOS**

PORTAS DE 15mm À 20mm DE ESPESURA

AS ROLDANAS DEVEM SER SOBREPOSTAS.

**FURAÇÃO DOS TRILHOS**

FURAR TRILHOS A 50mm DA EXTREMIDADE E A CADA 300mm ATÉ A OUTRA EXTREMIDADE

FURAR TRILHOS A 50mm DA EXTREMIDADE E A CADA 300mm ATÉ A OUTRA EXTREMIDADE

TRILHO PODE SER APLICADO NO MÓVEL COM FITA DUPLA FACE

**FURAÇÃO DAS PORTAS**

**GUIA INTELIGENTE GA 10**

GUIA GA 10 LIGHT  
RODÍZIO EM POLÍMERO INJETADO PARA TRILHOS DE 26MM ATÉ 32MM

GUIA GA 10 FAST  
ROLAMENTO EMBORRACHADO PARA TRILHOS DE 26MM ATÉ 32MM

\*\*\* A GUIA GA 10 POSSUI TRAVA OCULTA PARA A INSTALAÇÃO DAS PORTAS DO MÓVEL.  
\*\*\* POSSUI AJUSTAMENTO (LIBERAÇÃO DOS ROLETEIS) PELA LATERAL.  
\*\*\* POSSUI AJUSTE AUTOMÁTICO À LARGURA DO TRILHO ATRAVÉS DE LIBERAÇÃO DE MOLAS.  
\*\*\* POSSUI AJUSTE DA POSIÇÃO E FIXAÇÃO DOS ROLETEIS, NAS LARGURAS DE TRILHOS 26 E 32MM, ALEM DE POSSUIR MOLAS EMBUTIDAS PARA CORRIGIR EVENTUAIS DEFEITOS DOS TRILHOS.  
\*\*\* RECOMENDA-SE TRAVAR AS GUIAS NAS POSIÇÕES PARA USO COM AMORTECEDOR AN 30c.

PARA TRILHOS DE 26MM, TRAVAR A GUIA NA POSIÇÃO INDICADA.

PARA TRILHOS DE 32MM, TRAVAR A GUIA NA POSIÇÃO INDICADA.

**GUIA INTELIGENTE GA 10**

PARA USO EM PORTAS COM PERFIS DE ALUMÍNIO E VIDRO, SEMPRE TRAVAR A GUIA PARAFUSANDO NO SENTIDO DA PARTE TRASEIRA DA PORTA, PARA QUE O PARAFUSO DE FIXAÇÃO NÃO INVADA A ÁREA DO VIDRO;

PARTE TRASEIRA

FURAÇÃO DA PORTA PARA INSTALAÇÃO DA GUIA

# SISTEMA DE CORRER

103746-SISTEMA DE CORRER 2082 P/ 1 PORTA - ALTERNATIVA

**ALTERNATIVA**  
 MANUAL DE INSTRUÇÕES SISTEMA 2082

TRILHO 2082

CAIXA DE ACABAMENTO 2092

CÓD. 2082.1.10

PARAFUSO SISTEMA LINE 5/16 x 114  
 ARRUELA SISTEMA 6,3/16  
 PORCA SISTEMA 6,3/16  
 SUPORTE SOBREPÓSITO  
 ROLDANA 2082  
 CHAVE DE BICA Nº 13  
 CHAVE DE BICA Nº 14

**DESCONTOS DE PORTA**

PORTA DE MADEIRA OU DE ALUMÍNIO

49mm

8mm

PORTA = VAU DO MÓVEL - 57mm

10  
8

USINAGEM NA PARTE INFERIOR DA PORTA

103748 - PERFIL TRILHO SUP 2082 ANOD

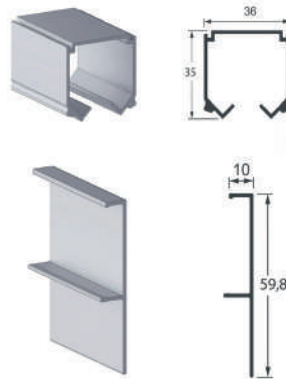

103749 - PERFIL ACABAMENTO 2092 ANOD

**MONTAGEM DA ROLDANA SUPERIOR 2082**

INSIRA A ARRUELA NO PARAFUSO, E NA SEQUENCIA ROSQUEIE A PORCA

ROSQUEIE O PARAFUSO NA ROLDANA

**POSICIONAR FREIOS E ROLDANAS**

POSICIONAR ROLDANAS E FREIOS NO TRILHO ANTES DE FIXÁ-LOS

**POSIÇÃO FREIO E SUPORTE SOBREPÓSITO**

30,5 (madeira)  
90 (alumínio)

10 (madeira)  
53,5 (alumínio)

**ENCAIXAR PORTA NAS ROLDANAS**

SUPORTE ENCAIXADO ENTRE AS DUAS PORCAS DO PARAFUSO

**POSIÇÃO FREIO E FIXAR PORTA**

10 (MADEIRA)  
53,5 (ALUMÍNIO)

LATERAL DA PORTA

X = 30,5 (MADEIRA)  
X = 90 (ALUMÍNIO)

CHAVE DE BICA Nº 13 INCLUSA NO SISTEMA

# SISTEMA DE CORRER

103747-SISTEMA DE CORRER MAGIC 62 C/ GUIA INTELIGENTE GA10 LIGHT - ALTERNATIVA

**ALTERNATIVA**  
MANUAL DE INSTRUÇÕES MAGIC 62

**ROLIÃO MAGIC 62 x2**  
ROLIÃO x2

GUIA SUPERIOR x2  
GA 01, GA 03 E GA 10.  
VERIFIQUE O MODELO DA  
GUIA NA EMBALAGEM

PARAFUSOS PHILIPS  
CABEÇA CHATA (3,5x25mm) x2  
FLANGADO (3,5x14mm) x5  
FLANGADO (3,5x20mm) x5

**INFORMAÇÕES**

01. O MAGIC 62 PODE SER UTILIZADO EMBUTIDO OU SOBREPOSTO;  
02. PARA PORTAS DE MADEIRA E ALUMÍNIO;  
03. PARA NÍVEL COM SISTEMAS ABERTOS DE BASE;  
04. DESENVOLVIDO PARA SUPLICAR CARGAS DE ATÉ 80 KG;  
05. POSSUI UM SISTEMA DE INÍMPIA PARAFUSO LATERAL, QUE  
PERMITE O PERFEITO AJUSTE DAS PORTAS;  
06. SISTEMA COM PARAFUSO AUTOMÁTICO AGLIJANÇA MOVILIZAM  
E POSSIBILANDO UMA MAIOR SEGURANÇA;  
07. DESIGN DIFERENCIADO, BASEADO NA INTENÇÃO DE ATRIBUIR  
ROBUSTEZ AO PRODUTO;  
08. NOVA COLEÇÃO QUATRE;  
09. ADOÇÃO DE GRAFENO NA NOVA COMPOSIÇÃO, QUE PROPORCIONA  
MAIOR RESISTÊNCIA, EFICIÊNCIA E DURABILIDADE.

**DESCRITOS**

AS ROLDANAS PODEM SER SOBREPOSTAS OU EMBUTIDAS:  
SISTEMA SOBREPOSTO, PARA PORTAS DE 15 A 27MM; SISTEMA EMBUTIDO, PARA PORTAS DE 15 A 27MM.

Altura da porta: 150 - 231mm  
Altura da porta: 150 - 231mm

**TIRILHOS E FURAÇÕES**

**PARA APLICAÇÃO EMBUTIDA:**  
TIRILHO SUPERIOR: 3050  
TIRILHO INFERIOR: 1050  
2050

**PARA APLICAÇÃO SOBREPOSTA:**  
TIRILHO SUPERIOR: 2057  
TIRILHO INFERIOR: 1052  
2052

FURAR OS TIRILHOS SUPERIOR E INFERIOR A 50MM DA EXTREMIDADE E A CADA 300MM ATÉ A OUTRA EXTREMIDADE.  
TIRILHO PODE SER RELIADO NO MÓVEL COM FURA DUPLA FACE

**FIXAÇÃO DO SISTEMA NAS PORTAS**

MAGIC 62 EMBUTIDO - FURAÇÃO E USINAGEM

PROFUNDIDADE DA USINAGEM = 5MM

MAGIC 62 SOBREPPOSTO - FURAÇÃO

**INSTALAR FREIOS**

3,5x25  
CABEÇA CHATA

13,5

**ACESSÓRIOS**

O SISTEMA MAGIC 62 É COMPATÍVEL COM O AMORTECEDOR AM 36;  
O AMORTECEDOR AM 36 SUPORTA ATÉ 80KG;  
CONSIDERE 1 AMORTECEDOR POR PORTA.

**INSTALAÇÃO DA PORTA**

INSERIR AS PORTAS DE ACORDO COM A FIGURA ABAIXO.

1. COM AS ROLDANAS RECOLHIDAS, ENCAIXE A PORTA INTERNA PELA PARTE SUPERIOR.
2. ENCAIXE A PARTE INFERIOR DA PORTA.
3. REPITA O PROCESSO COM A PORTA EXTERNA.

**REGULAR ROLDANA**

REGULAR ROLDANA ATRAVÉS DO PARAFUSO LATERAL,  
LIBERANDO OS ROLÍZOS E DEIXANDO  
ARMADO O SISTEMA ANTIDESCARRILAMENTO.

ACCESSE E  
SABÁ MAIS

**ALTERNATIVA**  
ALTERNATIVA COMPONENTES LTDA.  
CNPJ: 04.672.201/0001/14  
Fone: +55 (54) 4009-8888  
www.alternativa.br

**GUIA INTELIGENTE GA 10**

GUIA GA 10 LIGHT  
RODZIO EM POLÍMERO INJETADO PARA  
TIRILHOS DE 26MM ATÉ 32MM

GUIA GA 10 FAST  
ROLAMENTO EMBORRACHADO PARA  
TIRILHOS DE 26MM ATÉ 32MM

\*\*\* A GUIA GA 10 POSSUI TRAVA OCULTA PARA A INSTALAÇÃO DAS PORTAS DO MÓVEL.  
\*\*\* POSSUI ACOIONAMENTO (LIBERAÇÃO DOS ROLÍZOS) PELA LATERAL.  
\*\*\* POSSUI AJUSTE AUTOMÁTICO À LARGURA DO TIRILHO ATRAVÉS DE LIBERAÇÃO DE MOLA.  
\*\*\* POSSUI AJUSTE DA POSIÇÃO E FIXAÇÃO DOS ROLÍZOS, NAS LARGURAS DE TIRILHOS 26 E 32MM, ALÉM DE POSSUIR MOLA EMBUTIDA PARA CORRIGIR EVENTUAIS DEFEITOS DOS TIRILHOS.  
\*\*\* RECOMENDA-SE TRAVAR AS GUIAS NAS POSIÇÕES PARA USO COM AMORTECEDOR AM 36.

PARA TIRILHO DE 26MM: Travar a guia na posição normal

PARA TIRILHO DE 32MM: Travar a guia na posição normal

**GUIA INTELIGENTE GA 10**

PARA USO EM PORTAS COM PERFS DE ALUMÍNIO E VIDRO, SEMPRE TRAVAR A GUIA PARAFUSANDO NO SENTIDO DA PARTE TRASEIRA DA PORTA, PARA QUE O PARAFUSO DE FIXAÇÃO NÃO INVADA A ÁREA DO VIDRO.

Fixação da porta mais próxima da guia

70 87



# SISTEMA DE CORRER

102016 - SISTEMA DE CORRER AEREO SENSE P/01 PORTA GRAFITE 2,0MT - ALTERNATIVA

102017 - SISTEMA DE CORRER AEREO SENSE P/01 PORTA POLIDO 2,0MT - ALTERNATIVA

SISTEMA DE CORRER



Cores Disponíveis



Polido



Preto



Bronze 1001



Grafite

# SISTEMA DE CORRER

102113-SISTEMA DE CORRER RO62 UNIVERSAL - ROMETAL

## RO 62



Portas de até 60 kg



Altura da porta Vão Interno -35 mm



Sistema Sobreposto



Mola Antideslizamento



Sustentação na Base



Rolamento Blindado



Portas de Madeira e Alumínio

### Instalação



Posicionamento do Guia

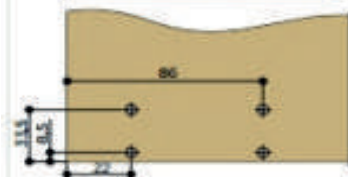

Aplicação em Madeira

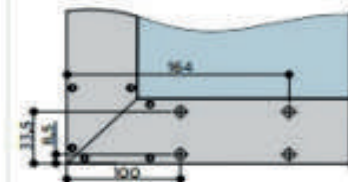

Aplicação em Alumínio



### Dimensionamento (mm)

Espessuras de portas, guias e trilhos

Porta de 15 mm

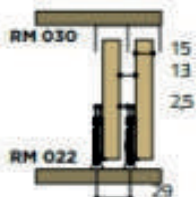

GUIA 4002

Porta de 18 mm

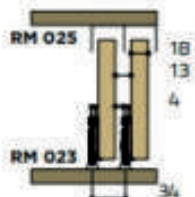

GUIA 4011/4013

Porta de 20 mm

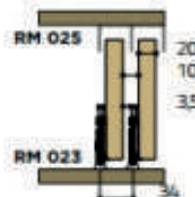

Porta de 22 mm

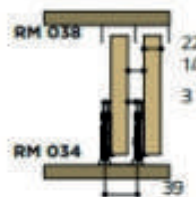

GUIA 4012

Porta de 25 mm

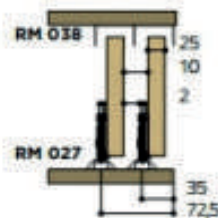

GUIA 4012

# SISTEMA DE CORRER

102112-SISTEMA DE CORRER RO47 UIVERSAL - ROMETAL

## RO 47



RO.474025	4025		26 - 32 mm
-----------	------	--	------------

### Instalação

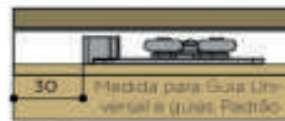

Posicionamento do Guia

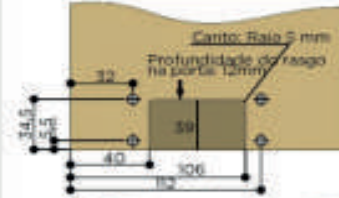

Aplicação em Madeira

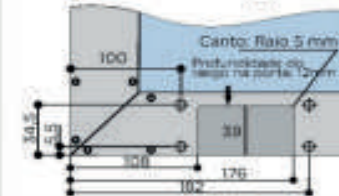

Aplicação em Alumínio



### Dimensionamento (mm)

Espessuras de portas, guias e trilhos

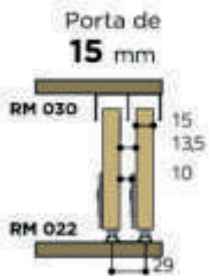

Porta de 15 mm

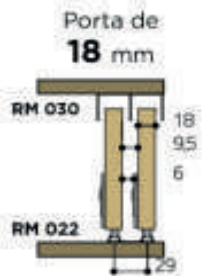

Porta de 18 mm

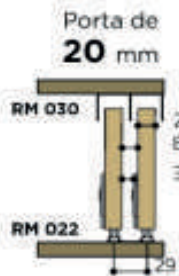

Porta de 20 mm

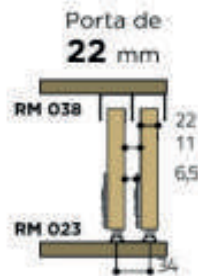

Porta de 22 mm

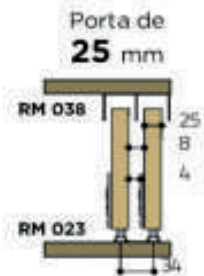

Porta de 25 mm

GUIA 4002

GUIA 4012

# SISTEMA DE CORRER

103805 - SISTEMA DE CORRER DOMINUS TOP/2 MEDIO (20-50KG) - ROMETAL

103806 - SISTEMA DE CORRER DOMINUS TOP/3 MEDIO (20-50KG) - ROMETAL

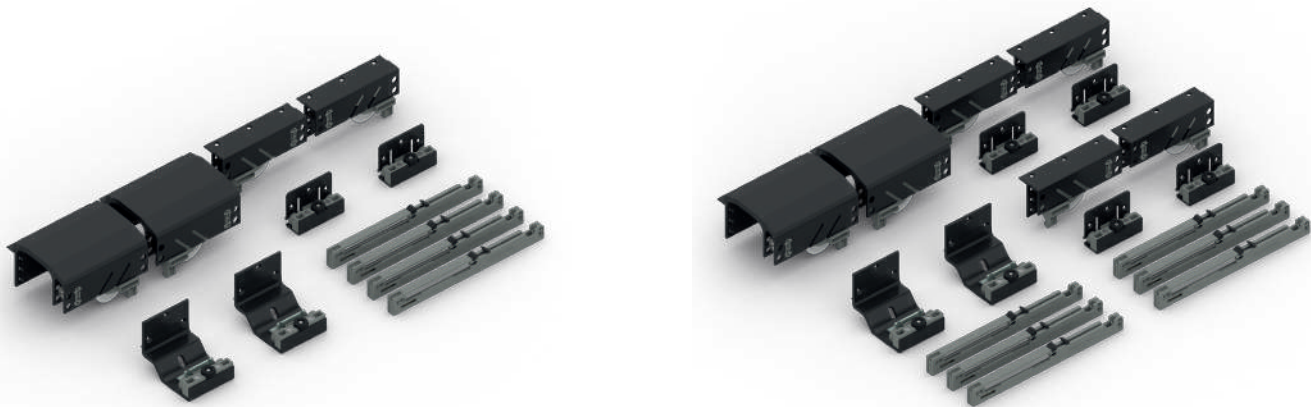

SISTEMA DE CORRER

		Itens na caixa / Items en la caja					
		Carro Externo	Carro Interno	Guia/ Guia Inferior Externo	Guia/ Guia Inferior Interno	Amortecedor Amortiguador	Br Soft
2 portas	2 puertas	2	2	2	2	4	-
3 portas	3 puertas	2	4	2	4	6	2

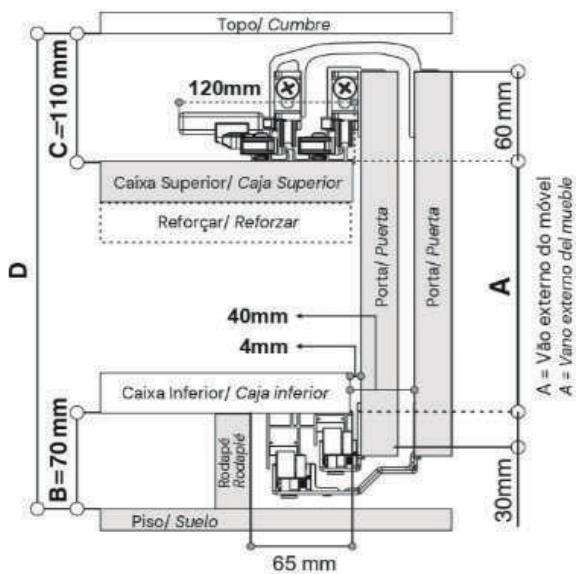

103847-TRILHO SUPERIOR AL RM-265 DOMINUS ANOD 6MT ROMETAL

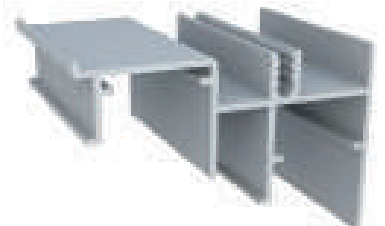
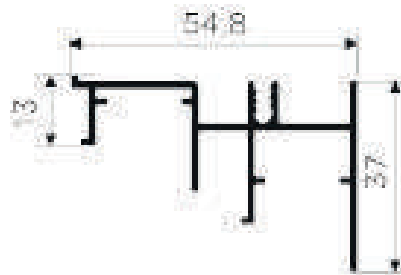

103846-TRILHO INFERIOR AL RM-264 DOMINUS ANOD 6MT ROMETAL

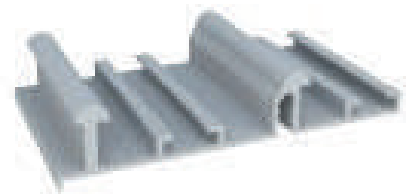

# SISTEMA DE CORRER

101851-AMORTECEDOR SOFTDOOR SLOW P/PORTAS



Montagem Dispositivo *Slowmotion* no trilho superior

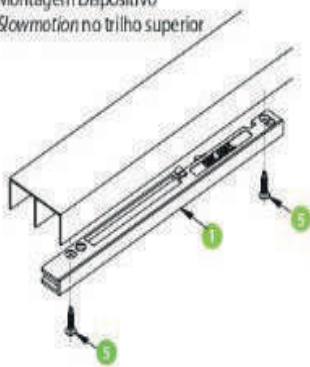

Montagem porta com perfil de alumínio

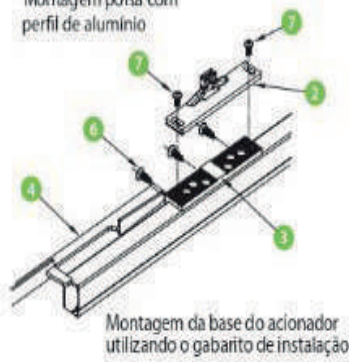

Montagem da base do acionador utilizando o gabarito de instalação

Montagem porta de MDF

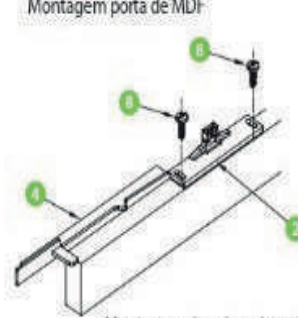

Montagem do acionador utilizando o gabarito de instalação

Dimensões para Instalação:

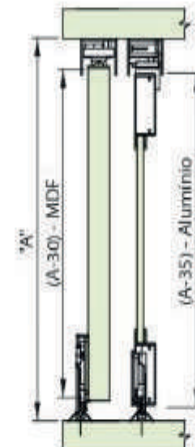
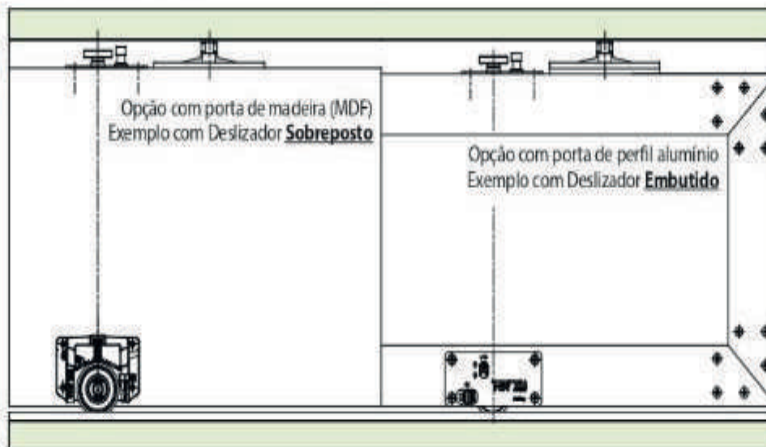

# SISTEMA DE CORRER

103712-SISTEMA DE CORRER JP25 C/ GUIA MOLA/RODA - JOELINI

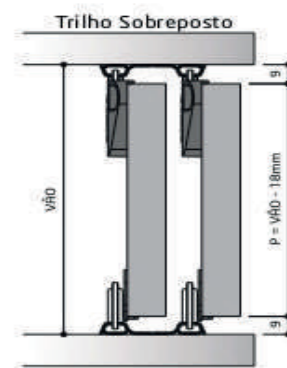
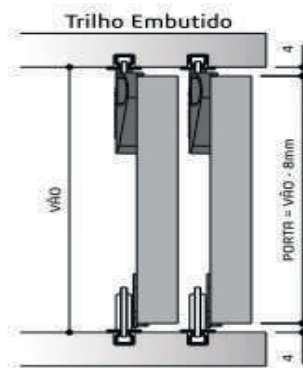

## ESPESSURA DAS PORTAS, TRILHOS E DISTANCIAMENTO RECOMENDADOS

**Porta de 15mm**

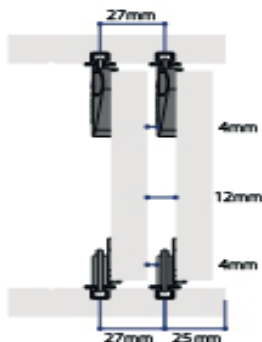

**Porta de 18mm**

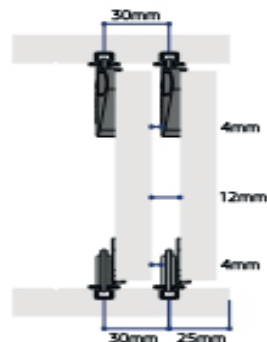

**Porta de 20mm**

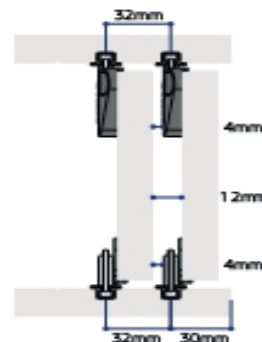

# SISTEMA DE CORRER

103711-SISTEMA DE CORRER JP700 V10/RODA CONVEXA/FIX TOPO - JOELIN

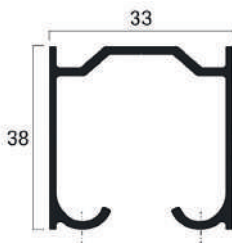
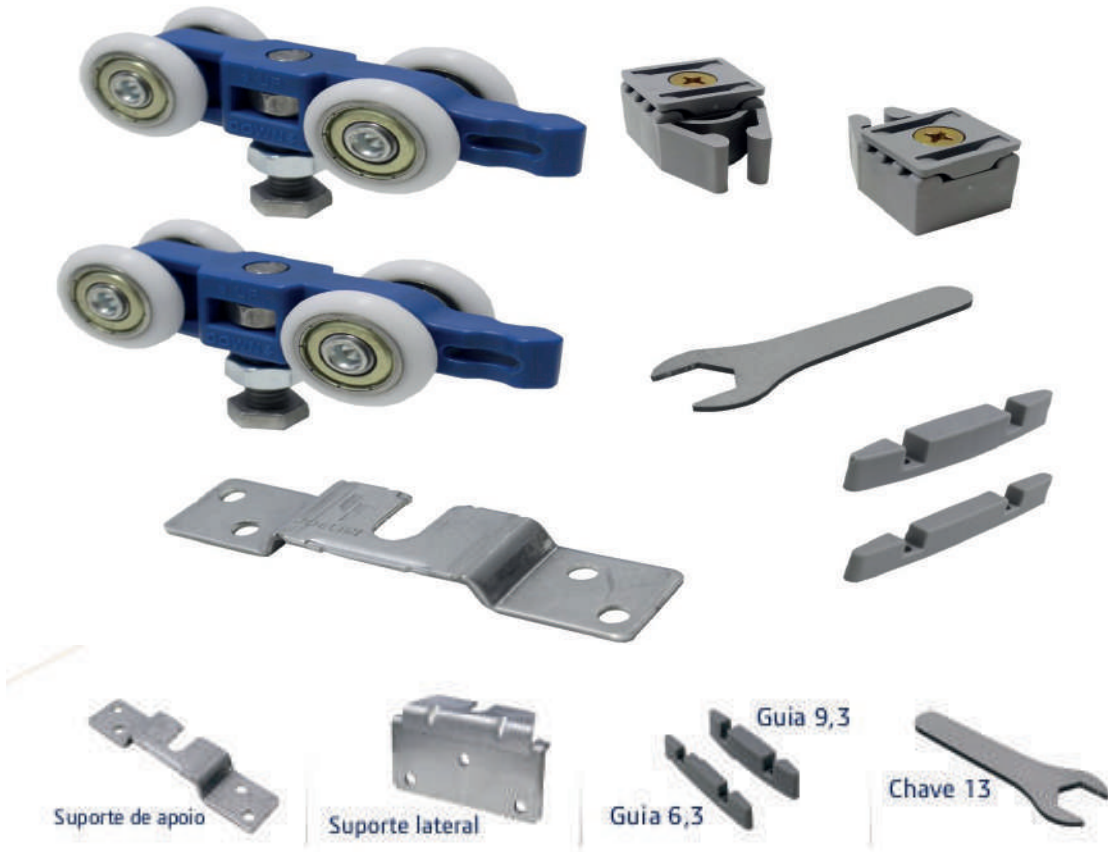

103837 -TRILHO SUPERIOR JP700 CONVEXA ANODIZADO 3MT

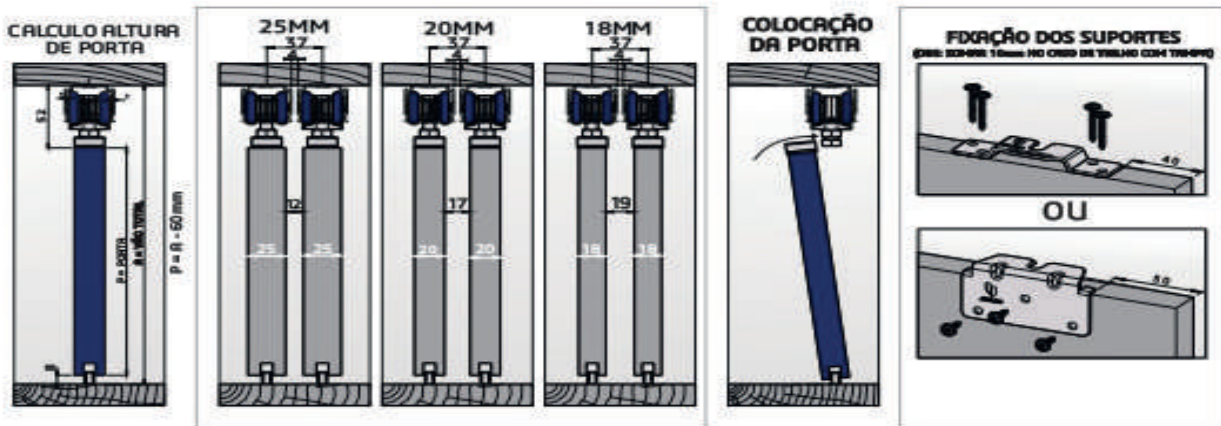

# SISTEMA DE CORRER

103247-SISTEMA DE CORRER KIT JP360 GUIA UNIV FOLGA ZERO - JOELINI

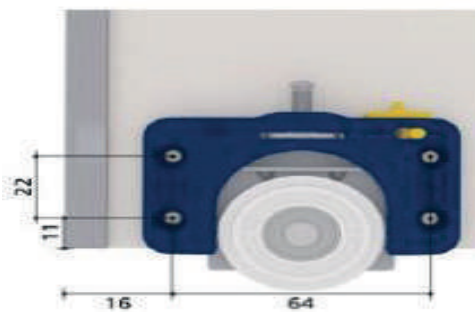
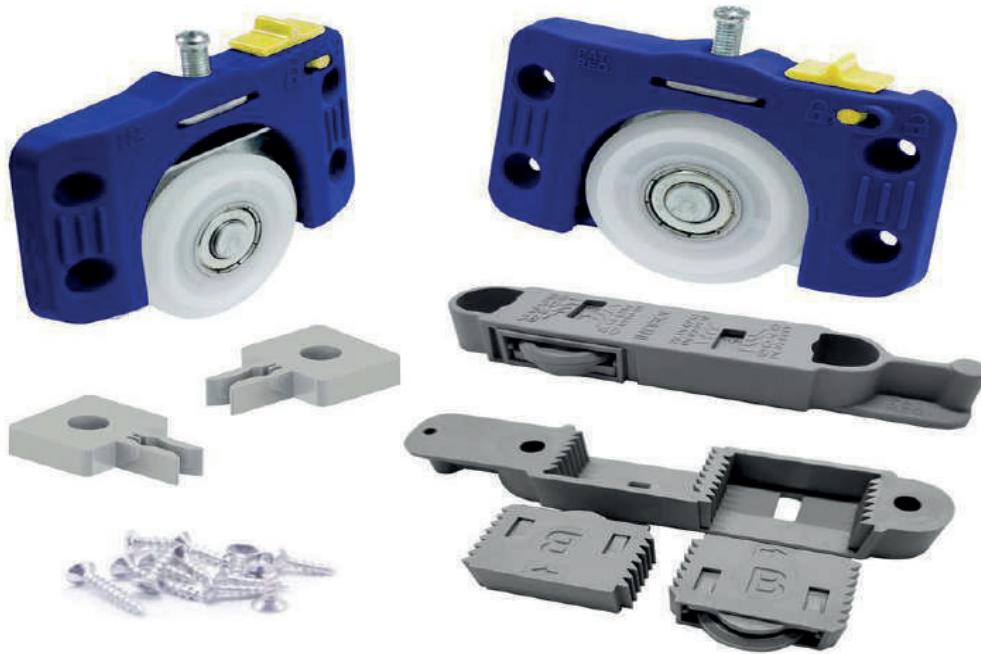

**ESPESSURA DAS PORTAS, TRILHOS E DISTANCIAMENTO RECOMENDADOS**

Porta de 15mm	Porta de 18mm	Porta de 20mm	Porta de 22mm	Porta de 25mm



# SISTEMA DE CORRER

## 102957-SISTEMA DE CORRER CM190 C/ GUIA - UNIVERSAL

### SISTEMA CM 190

FIXAÇÃO QUANDO SOBREPOSTA  
FIXAÇÃO QUANDO EMBUTIDA

EMBUTIDO OU SOBREPOSTO

- SUSTENTAÇÃO NA BASE
- CARGA MÁXIMA 50kg
- SOBREPOSTO OU EMBUTIDO
- MOLLA
- RODÍZIO COM ROLAMENTO
- 28 ou 28
- TRILHO SUPERIOR
- TRILHO INFERIOR
- ALTURA DA PORTA = VÃO - 34mm (SMART) VÃO - 34mm (UNIVERSAL) VÃO - 31mm (1 RODÍZIO)

DESCRIÇÃO	COD.
SISTEMA CM 190 MULT - GUIA UNIVERSAL	12681

### VISTA FRONTAL (mm)

● SOBREPONTO

● EMBUTIDO

### VISTA LATERAL (mm)

● SOBREPONTO

PORTAS DE 15mm	PORTAS DE 18mm	PORTAS DE 20mm	PORTAS DE 22mm	PORTAS DE 25mm

● EMBUTIDO

PORTAS DE 15mm	PORTAS DE 18mm	PORTAS DE 20mm	PORTAS DE 22mm	PORTAS DE 25mm



## 102958-SISTEMA DE CORRER CM100 C/ GUIA - UNIVERSAL

### SISTEMA CM 100

- SUSTENTAÇÃO NA BASE
- CARGA MÁXIMA 40kg
- SOBREPONTO
- MOLLA
- RODÍZIO COM ROLAMENTO
- 28 ou 28
- TRILHO SUPERIOR
- TRILHO INFERIOR
- ALTURA DA PORTA = VÃO - 34mm (SMART) VÃO - 34mm (UNIVERSAL) VÃO - 31mm (1 RODÍZIO)

DESCRIÇÃO	COD.
SISTEMA CM 100 - GUIA UNIVERSAL	14918

### VISTA FRONTAL (mm)

● SOBREPONTO

● GUIA UNIVERSAL

### VISTA LATERAL (mm)

● SOBREPONTO

PORTAS DE 15mm	PORTAS DE 18mm	PORTAS DE 20mm	PORTAS DE 22mm	PORTAS DE 25mm



# SISTEMA DE CORRER

103713-AMORTECEDOR FOLGAZERO KIT 2



SISTEMA DE CORRER

## DIFERENCIAIS

- DISPENSA USO DE CHAVES E REGULAGENS
- SILENCIOSO E SEGURO
- MAIOR PRATICIDADE PARA O MONTADOR
- PARA PORTAS DE ALUMÍNIO E MADEIRA
- OPÇÕES PARA TRILHOS DE:  
27mm, 28,5mm, 30mm, 32mm E 33,5mm

Capacidade de peso: 35kg

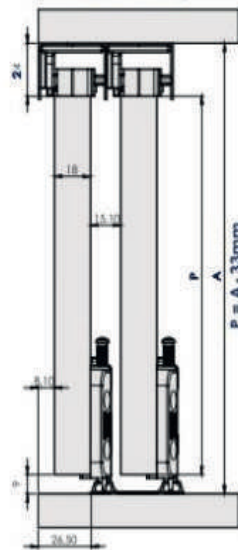

Largura mínima recomendada: 800mm

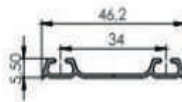
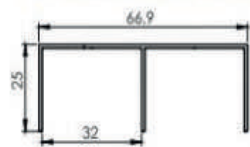

# ILUMINAÇÃO



101842-INTERRUPTOR P/ MOVEIS  
ABNT PARALELO BRANCO,



101843-INTERRUPTOR P/ MOVEIS  
ABNT PARALELO PRETO



101847-TOMADA P/ MOVEIS  
ABNT 20A PRETO



101846-TOMADA P/ MOVEIS  
ABNT 20A BRANCA

101844-INTERRUPTOR P/ MOVEIS  
ABNT SIMPLES BRANCO

101845-INTERRUPTOR P/ MOVEIS  
ABNT SIMPLES PRETO

**1º Marque a distância de 24mm e faça 2 furos de Ø35mm**



**2º Coloque o interruptor ou tomada e fixe os parafusos**



**3º Encaixe o acabamento (Aro)**



102792-INTERRUPTOR P/ LED  
LIG/DESL. BRANCO



102791-INTERRUPTOR P/ LED  
LIG/DESL. MARROM



102793-INTERRUPTOR P/ LED  
LIG/DESL. CINZA



102794-INTERRUPTOR P/ LED  
LIG/DESL. PRETO



102247-TORRE DE TOMADA  
C2 TOMADAS +2 USB



102248-TORRE DE TOMADA  
C3 TOMADAS

# ILUMINAÇÃO



102800-LUMINARIA POINT CIRCULAR 1,5W 110/220V 3000K OURO VELHO - QUENTE

102807-LUMINARIA POINT CIRCULAR 1,5W 110/220V 6000K OURO VELHO FRIO



102814-LUMINARIA POINT QUADRADA 1,5W 110/220V 3000K OURO VELHO - QUENTE

102820-LUMINARIA POINT QUADRADA 1,5W 110/220V 6000K OURO VELHO FRIO



102802-LUMINARIA POINT CIRCULAR 1,5W 110/220V 3000K ROSE - QUENTE

102809-LUMINARIA POINT CIRCULAR 1,5W 110/220V 6000K ROSE FRIO

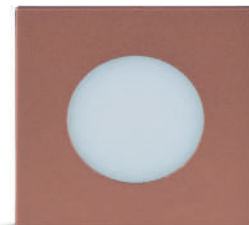

102815-LUMINARIA POINT QUADRADA 1,5W 110/220V 3000K ROSE - QUENTE

102822-LUMINARIA POINT QUADRADA 1,5W 110/220V 6000K ROSE FRIO



102797-LUMINARIA POINT CIRCULAR 1,5W 110/220V 3000K COBRE - QUENTE

102804-LUMINARIA POINT CIRCULAR 1,5W 110/20V 6000K COBRE FRIO



102811-LUMINARIA POINT QUADRADA 1,5W 110/220V 3000K COBRE - QUENTE

102817-LUMINARIA POINT QUADRADA 1,5W 110/220V 6000K COBRE FRIO



102799-LUMINARIA POINT CIRCULAR 1,5W 110//220V 3000K GRAFITE - QUENTE

102806-LUMINARIA POINT CIRCULAR 1,5W 110/220V 6000K GRAFITE FRIO



102813-LUMINARIA POINT QUADRADA 1,5W 110/220V 3000K GRAFITE - QUENTE

102819-LUMINARIA POINT QUADRADA 1,5W 110/220V 6000K GRAFITE FRIO



102796-LUMINARIA POINT CIRCULAR 1,5W 110/220V 3000K BRANCO - QUENTE

102803-LUMINARIA POINT CIRCULAR 1,5W 110/220V 6000K BRANCO (1) FRIO



102810-LUMINARIA POINT QUADRADA 1,5W 110/220V 3000K BRANCO - QUENTE

102816-LUMINARIA POINT QUADRADA 1,5W 110/220V 6000K BRANCO FRIO



102798-LUMINARIA POINT CIRCULAR 1,5W 110/220V 3000K CROMADO - QUENTE

102805-LUMINARIA POINT CIRCULAR 1,5W 110/220V 6000K CROMADO FRIO



102812-LUMINARIA POINT QUADRADA 1,5W 110/220V 3000K CROMADO - QUENTE

102818-LUMINARIA POINT QUADRADA 1,5W 110/220V 6000K CROMADO FRIO



102801-LUMINARIA POINT CIRCULAR 1,5W 110/220V 3000K PRETO - QUENTE

102808-LUMINARIA POINT CIRCULAR 1,5W 110/220V 6000K PRETO FRIO



102821-LUMINARIA POINT QUADRADA 1,5W 110/220V 6000K PRETO

102826-LUMINARIA POINT QUADRADA 1,5W 110/220V 3000K PRETO - QUENTE FRIO



102781-CABIDEIRO LED 6000K 1200MM SENSOR MOV ALUMI  
102782-CABIDEIRO LED 6000K 850MM SENSOR MOV ALUMI

# ILUMINAÇÃO



102789 -FITA LED 3528 C/SILICONE  
3000K 5MT- QUENTE



102790 - FITA LED 3528 S/SILICONE 240  
LED/M 3000K 5MT- QUENTE



103697-FITA LED 60 LEDS/  
M FRIO 5MT KIT BLISTER E FONTE



102784-CONECTOR CABO  
E EMENDA PFITA 3528 2VIAS P4



102788-EMENDA FITA 3528



102785-CONECTOR  
CABO PFITA LED 3528

# ILUMINAÇÃO

**KIT LED COM 2 METROS**

**FITA 120 LEDs**  
 Potência: 12 w/m  
 Lúmens: 800 por metro  
 Voltagem: 12v

**+ FONTE**  
 12v Bivolt | 2A – 24w

**+ CAPA PARA LED**

**BQ**  
 Branco Quente 3.000k

**BN**  
 Branco Neutro 4.000k

**BF**  
 Branco Frio 6.000k

**USINAGEM**  
 10.5mm  
 12mm

**Sulfer**

PHOTOLOGIA POR **iluminoteca** LUMINOTEC

# ILUMINAÇÃO

103752 - KIT LEDS BRANCO NEUTRO 5MT  
 FONTE 5A-60W + DIFUSOR DMD + FITA 120 LEDS/

103753 - KIT LEDS BRANCO QUENTE 5MT FONTE  
 5A-60W + DIFUSOR DMD + FITA 120 LEDS/

103754 - KIT LEDS BRANCO FRIO 5MT FONTE 5A-60W  
 + DIFUSOR DMD + FITA 120 LEDS/M

103755 - KIT LEDS BRANCO NEUTRO 2MT FONTE 2A-24W  
 + DIFUSOR DMD + FITA 120 LEDS/

103756 - KIT LEDS BRANCO QUENTE 2MT FONTE 2A-24W  
 + DIFUSOR DMD + FITA 120 LEDS/

103757 - KIT LEDS BRANCO FRIO 2MT FONTE  
 2A-24W + DIFUSOR DMD + FITA 120 LEDS/M

# DIVISÓRIAS



102568-DIVISORIA EUC BRANCO UV - 1202X2110X35 - EUCATEX  
 102598-PORTA DIVISORIA 820X2110X35BRANCO UV -EUCATEX  
 102571-PERFIL EUC BRANCO BAT PORTA N21AH - 832MMMM - EUCATEX  
 102572-PERFIL EUC BRANCO BAT PORTA N21AV - 2128MM - EUCATEX  
 102573-PERFIL EUC BRANCO H NTR - 1185MM - EUCATEX  
 102574-PERFIL EUC BRANCO H NTR - 2150MM - EUCATEX  
 102575-PERFIL EUC BRANCO H NTR - 3000MM - EUCATEX  
 102576-PERFIL EUC BRANCO P/REQUADRO PORTA N21B - 2110MM - EUCATEX  
 102577-PERFIL EUC BRANCO P/REQUADRO PORTA N21B - 806MM - EUCATEX  
 102578-PERFIL EUC BRANCO P/VIDRO NBV-1 - 1185MM - EUCATEX  
 102579-PERFIL EUC BRANCO P/VIDRO NBV-2 - 1185MM - EUCATEX  
 102580-PERFIL EUC BRANCO U N19AE - 2150MM - EUCATEX  
 102581-PERFIL EUC BRANCO U N19AE - 3000MM - EUCATEX  
 102582-PERFIL EUC PRETO BAT PORTA N21AH - 832MM - EUCATEX  
 102583-PERFIL EUC PRETO BAT PORTA N21AV - 2128MM - EUCATEX  
 102584-PERFIL EUC PRETO H NTR - 1185MM - EUCATEX  
 102585-PERFIL EUC PRETO H NTR - 2150MM - EUCATEX  
 102586-PERFIL EUC PRETO H NTR - 2500MM - EUCATEX  
 102587-PERFIL EUC PRETO H NTR - 3000MM - EUCATEX  
 102588-PERFIL EUC PRETO P/REQUADRO PORTA N21B - 2110MM - EUCATEX  
 102589-PERFIL EUC PRETO P/REQUADRO N21B - 806MM - EUCATEX  
 102590-PERFIL EUC PRETO P/VIDRO NBV-1 - 1030MM - EUCATEX  
 102591-PERFIL EUC PRETO P/VIDRO NBV-1 - 1185MM - EUCATEX  
 102592-PERFIL EUC PRETO P/VIDRO NBV-2 - 1030MM - EUCATEX  
 102593-PERFIL EUC PRETO P/VIDRO NBV-2 - 1185MM - EUCATEX  
 102594-PERFIL EUC PRETO U N19AE - 2150MM - EUCATEX  
 102595-PERFIL EUC PRETO U N19AE - 2500MM - EUCATEX  
 102596-PERFIL EUC PRETO U N19AE - 3000MM - EUCATEX

## PORTA COMPLETA

1 FECHADURA  
 2 PERFIS REQUADRADO 2110MM  
 2 PERFIS REQUADRADO 806MM  
 1 BATENTE 2118MM  
 2 DOBRADIÇAS

## PARA VIDROS

4 PERFIS NBV1 1185  
 4 PERFIS NBV2 1185  
 4 PERFIS NBV1 1030  
 4 PERFIS NBV2 1030

# FERRAMENTAS



MARTELO UNHA POLIDO

- 102481-20MM
- 102482-25MM
- 102483-27MM
- 102484-29MM



102478-MARTELO PENA 200G CABO FIBRA

102480-MARTELO PENA 500G CABO FIBRA



102474-MARTELO BORRACHA BRANCO 40MM

102476-MARTELO BORRACHA BRANCO 60MM



102475-MARTELO BORRACHA PRETO 40MM

102477-MARTELO BORRACHA PRETO 60MM



102362-ALICATE UNIVERSAL 8



102359-ALICATE BICO MEIA CANA CURVO



102360-ALICATE BICO MEIA CANA RETO



- 102467-LIMA CHATA 8
- 102466-LIMA GROSSA MEIA CANA
- 102469-LIMA TRIANGULAR



- 102397 - CABO P/LIMA N1
- 102398 - CABO P/LIMA N2



- 102518-TRENA DE 3MT - LUFKIN
- 102517-TRENA DE 5MT - LUFKIN
- 103710-TRENA DE 8MT - LUFKIN



# FERRAMENTAS



- 102375-BROCA ACO RAPIDO 1,0MM
- 102366-BROCA ACO RAPIDO 1,5MM
- 102370-BROCA ACO RAPIDO 2,0MM
- 103709-BROCA ACO RAPIDO 2,5MM
- 102376-BROCA ACO RAPIDO 3,0MM
- 102377-BROCA ACO RAPIDO 4,0MM
- 102378-BROCA ACO RAPIDO 5,0MM
- 102371-BROCA ACO RAPIDO 6,0MM
- 102372-BROCA ACO RAPIDO 7,0MM
- 102373-BROCA ACO RAPIDO 8,0MM
- 102374-BROCA ACO RAPIDO 9,0MM
- 102367-BROCA ACO RAPIDO 10MM
- 102368-BROCA ACO RAPIDO 11MM
- 102369-BROCA ACO RAPIDO 12MM



- 102385-BROCA P.M.D. VIDEA 3MM
- 102386-BROCA P.M.D. VIDEA 4MM
- 102387-BROCA P.M.D. VIDEA 5MM
- 102388-BROCA P.M.D. VIDEA 6MM
- 102389-BROCA P.M.D. VIDEA 7MM
- 102390-BROCA P.M.D. VIDEA 8MM
- 102391-BROCA P.M.D. VIDEA 9MM
- 102383-BROCA P.M.D. VIDEA 10MM
- 102384-BROCA P.M.D. VIDEA 12MM



- FORMAO
- 102440 - 1"
  - 102441 - 1.1/2"
  - 102442 - 1/2"
  - 102443 - 3/4"
  - 102444 - 5/8"
  - 102445 - 7/8"



- 102461-LAMINA SERRA TICO-TICO 127D C/ 5 UN
- 102462-LAMINA SERRA TICO-TICO 144D C/ 5 UN



- CHAVE FENDA
- 102413 - 1/4X4
  - 102414 - 1/4X8
  - 102415 - 1/8X3
  - 102416 - 3/16X4
  - 102417 - 3/16X6



- CHAVE PHILLIPS
- 102418 - 1/4X4
  - 102419 - 1/4X6
  - 102420 - 1/8X3
  - 102421 - 3/16X4
  - 102422 - 3/16X6

# FERRAMENTAS



102465-LAPIS CARPINTEIRO



102430 - ESPÁTULA 3" CABO PLASTICO



FRESA P/DOBRADIÇA  
102446 - 26MM  
102447 - 35MM



102453-GRAMPO SARGENTO 250X80MM  
102454-GRAMPO SARGENTO 600X80MM



102432 - ESQUADRO 12" CABO ALUMINIO  
102433 - ESQUADRO 12" CABO PLASTICO



102452-GRAMPO MOLA



103848 -ESCAREADOR COM  
CROCA PILOTO 12X4.0MM



102945 -PONTEIRA PHILIPS P/  
PARAFUSADEIRA PH265L



102464-LAMINA SERRA BIMETAL



102364-ARCO DE SERRA 12" C/ REGULAGEM

# FERRAMENTAS



102470-LUVA LATEX NEOMIX



102471-LUVA MALHA NITRILON VERDE



102492-PROTETOR AURICULAR PLUG



102488-PINCEL 1"  
102489-PINCEL 1/2"



102485-MASCARA  
DESCARTAVEL AZUL



102138 - PLASTICO BOLHA



102491-PROTETOR ABAFADOR CONCHA



102964-ESTOPA POLIMAXX BRANCA 1 KG



102487-OCULOS INCOLOR

## FERRAMENTAS



103481-BATENTE INCOLOR 8MM  
CARTELA COM 50 UN

103480-BATENTE INCOLOR 15MM  
CARTELA COM 50 UN



TAPA FURO EM  
VÁRIAS CORES



FITA DE BORDA PVC REHAU E PROADEC  
DIVERSOS PADRÕES E MEDIDAS 22/35/45/60/64/100/150MM

# FERRAMENTAS



**Bicos aplicadores**

- 103784 - APLICADOR TOPO MDF 15MM P/ ACAB DE MOVEIS - REHAU
- 103785 - APLICADOR TOPO MDF 18MM P/ ACAB DE MOVEIS - REHAU
- 103786 - APLICADOR TOPO MDF 25MM P/ ACAB DE MOVEIS - REHAU
- 103787 - APLICADOR TOPO MDF 30MM P/ ACAB DE MOVEIS - REHAU
- 103788 - APLICADOR TOPO MDF 36MM P/ ACAB MOVEIS - REHAU



**Centralizadores**

- 103790 - CENTRALIZADOR 22/15 PARA ACABAMENTO DE MÓVEIS
- 103791 - CENTRALIZADOR 22/18 PARA ACABAMENTO DE MÓVEIS
- 103792 - CENTRALIZADOR 35/25 PARA ACABAMENTO DE MÓVEIS
- 103793 - CENTRALIZADOR 35/30 PARA ACABAMENTO DE MÓVEIS
- 103794 - CENTRALIZADOR 45/30 PARA ACABAMENTO DE MÓVEIS
- 103795 - CENTRALIZADOR 45/36 PARA ACABAMENTO DE MÓVEIS



**Aplicadores de cola**

- 103796 - APLICADOR DE COLA P/ FITA 22MM - REHAU



**Adaptador para Aplicador**

- 103797 - ADAPTADOR PARA APLICADOR DE COLA 35MM
- 103798 - ADAPTADOR PARA APLICADOR DE COLA 45MM
- 103799 - ADAPTADOR PARA APLICADOR DE COLA 64MM

## FERRAMENTAS



103800 - REFILADOR DE  
FITA DE BORDA - REHAU



103801 - DESBOBINADOR  
P/ FITA DE BORDA - REHAU



103802 - LAMINA REFILADORA  
F 1 - 1,5 - 2 MM - REHAU